



مشاوره تحصیلی هیا

تخصصی ترین سایت مشاوره کشور

تماس با مشاوران ما، با شماره گیری

۹۰۹۹۰۷۵۳۰۵

از طریق تلفن ثابت

2nd Edition

Family and Friends 3

Workbook

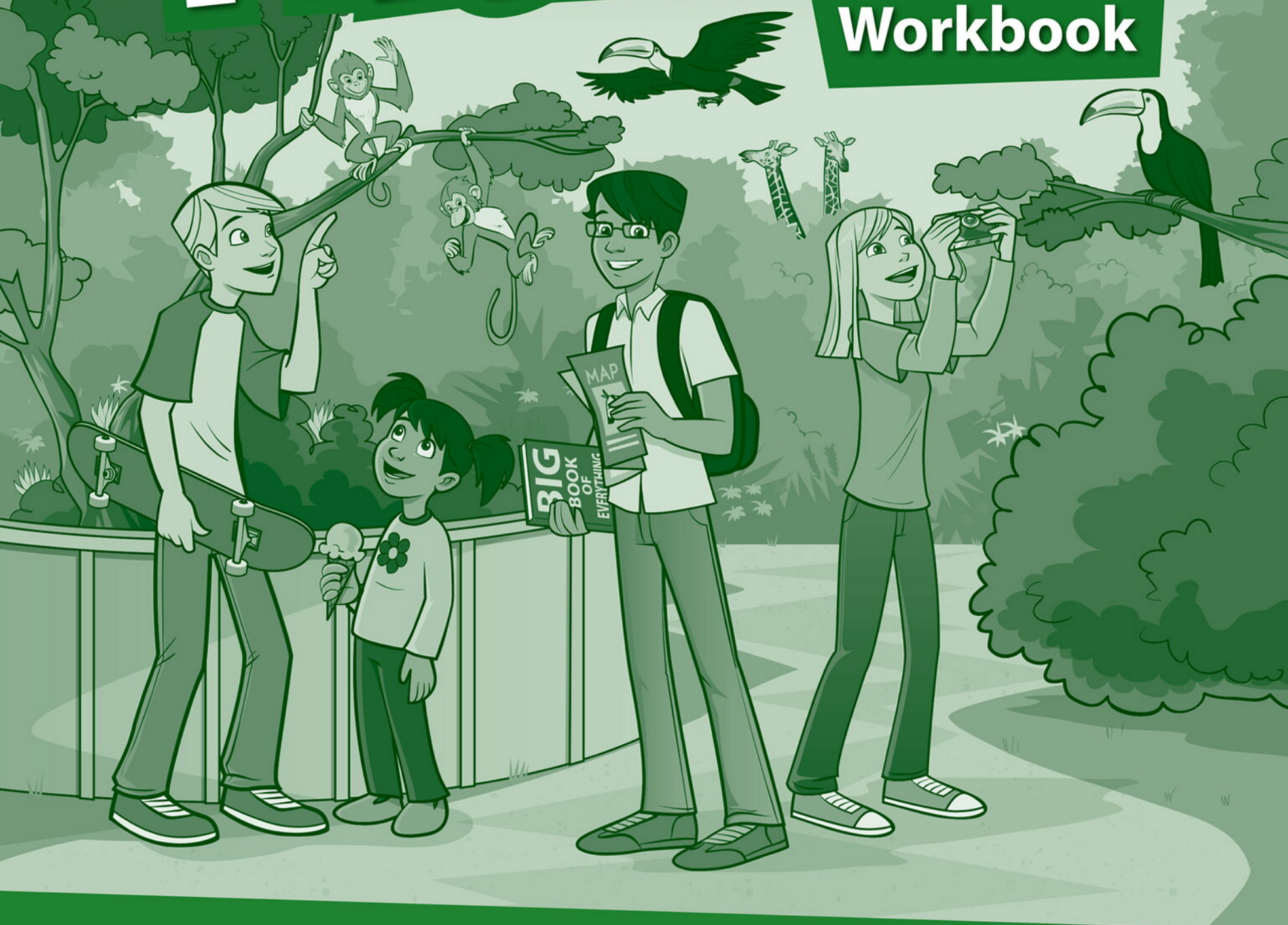

OXFORD

Liz Driscoll

2nd Edition

Family and Friends 3

Workbook



Liz Driscoll

OXFORD
UNIVERSITY PRESS

OXFORD
UNIVERSITY PRESS

Great Clarendon Street, Oxford, OX2 6DP, United Kingdom

Oxford University Press is a department of the University of Oxford.
It furthers the University's objective of excellence in research, scholarship,
and education by publishing worldwide. Oxford is a registered trade
mark of Oxford University Press in the UK and in certain other countries

© Oxford University Press 2014

The moral rights of the author have been asserted

First published in 2014

2018 2017 2016 2015 2014

10 9 8 7 6 5 4 3 2

No unauthorized photocopying

All rights reserved. No part of this publication may be reproduced, stored
in a retrieval system, or transmitted, in any form or by any means, without
the prior permission in writing of Oxford University Press, or as expressly
permitted by law, by licence or under terms agreed with the appropriate
reprographics rights organization. Enquiries concerning reproduction outside
the scope of the above should be sent to the ELT Rights Department, Oxford
University Press, at the address above

You must not circulate this work in any other form and you must impose
this same condition on any acquirer

Links to third party websites are provided by Oxford in good faith and for
information only. Oxford disclaims any responsibility for the materials
contained in any third party website referenced in this work

ISBN: 978 0 19 480806 4

Printed in China

This book is printed on paper from certified and well-managed sources

ACKNOWLEDGEMENTS

Illustrations by: Adrian Barclay (Beehive Illustration) pp.5, 9, 10 (Ex1), 15,
16 (Ex1), 21, 22 (Ex1), 31, 32 (Ex1), 37, 38 (Ex1), 43, 44 (Ex1), 53, 54 (Ex1), 59,
60 (Ex1, 2), 65, 72 (Ex1, 2), 75, 76 (Ex1), 81, 82 (Ex1), 87, 88 (Ex1), 95 (Ex4), 97,
103, 104 (Ex1), 109, 110 (Ex2); Kathy Baxendale pp.25, 63; Jared Beckstrand
pp.6, 10 (Ex3), 16 (Ex3), 22 (Ex2), 32 (Ex2), 38 (Ex2), 44 (Ex2), 54 (Ex3), 60 (Ex3),
62 (Ex2), 76 (Ex2), 82 (Ex2), 88 (Ex3), 98, 104 (Ex2), 110 (Ex3); Judy Brown
pp.26, 48, 70, 92, 114, 122, 123; Simon Clare pp.11, 17, 23, 33, 39, 45, 55, 61,
67, 77, 83, 89, 99, 105, 111; Steve Cox pp.13, 78 (Ex2); James Elston p.4; Paul
Gibbs pp.40 (Ex2), 41; John Haslam pp.12 (Ex2), 28 (Ex1), 29 (Ex4), 47, 50 (Ex1),
51 (Ex4), 73 (Ex4), 84, 94 (Ex1, 2), 116 (Ex1), 117 (Ex4); Andrew Hennessey pp.7,
8, 12 (Ex1), 14, 18, 19, 20, 24, 30, 34, 36, 40 (Ex1), 42, 52, 56 (Ex1), 58f, 62 (Ex1),
64, 68, 74, 78 (Ex1), 80, 86, 90 (Ex1), 96, 102, 106, 108; Carl Pearce (Advocate
Art) pp.35, 91, 100, 101, 113; Lesley Vamos (Andrea Brown Literary Agency)
pp.118; Ignatios Varsos p.66.

Commissioned photography by: David Jordan p.46.

Oxford University Press DVD stills: pp.27, 49, 71, 93, 115

*The Publishers would like to thank the following for their kind permission to reproduce
photographs and other copyright material:* **Alamy** pp.85 (Nabatean coin/Ancient
Art & Architecture Collection Ltd), 90 (wedding/ClassicStock), 112 (Barcelona
Zoo/Apix), 118 (Oxford High Street/Loop Images Ltd), 119 (London
Marathon/Ashok Saxena), 120 (girl in snow with hat/UpperCut Images);
Getty pp.120 (boy tennis serve/Olga Solovei); **iStock** pp.90 (young girl/
HultonArchive); **Shutterstock** pp.90 (old woman/Martina Ebel), 118 (girl/
Monkey Business Images).

Cover illustration by: James Elston

Contents

Starter	My family	4
Unit 1	They're from Australia!	8
	My writing: writing about myself	13
Unit 2	My weekend	14
	My writing: writing an email about my hobbies	19
Unit 3	My things	20
	My writing: writing about a child's collection	25
	Fluency Time! 1	26
	Review 1	28
Unit 4	We're having fun at the beach!	30
	My writing: writing a postcard about my trip	35
Unit 5	A naughty monkey!	36
	My writing: writing about animals	41
Unit 6	Jim's day	42
	My writing: writing information about me	47
	Fluency Time! 2	48
	Review 2	50
Unit 7	Places to go!	52
	My writing: writing an invitation email	57
Unit 8	I'd like a melon!	58
	My writing: writing a recipe	63
Unit 9	The fastest animal in the world	64
	My writing: writing about things I do	69
	Fluency Time! 3	70
	Review 3	72

Unit 10	In the park!	74
	My writing: writing school rules	79
Unit 11	In the museum	80
	My writing: writing about my town in the past and now	85
Unit 12	A clever baby!	86
	My writing: writing about my family	91
	Fluency Time! 4	92
	Review 4	94
Unit 13	The Ancient Egyptians	96
	My writing: writing about Ancient Egypt and today	101
Unit 14	Did you have a good day?	102
	My writing: writing about my school day	107
Unit 15	Our holiday!	108
	My writing: writing an email to a friend	113
	Fluency Time! 5	114
	Review 5	116
	Culture	118
	Everyday English Phrase bank	121
	Fluency Time! Review	122
	Grammar Time!	124
	Wordlist	135

Lesson One

1 Find and circle the family words in red and the numbers in blue.

Then write two lists.

family words

uncle

t	h	r	e	e	i	g	h	t
b	r	o	t	h	e	r	s	w
s	i	s	t	e	r	a	i	o
e	c	o	u	s	i	n	x	★
v	u	g	r	a	n	d	m	a
e	n	f	i	v	e	p	u	u
n	c	o	n	e	★	a	m	n
★	l	u	n	i	n	e	★	t
★	e	r	d	a	d	★	★	★

numbers

one

2 Look at Max and Holly's family photos. Write the sentences.

1 This is my sister.

2 _____

3 _____

4 _____

5 _____

6 _____

7 _____

8 _____

9 _____

10 _____

1 Circle the correct words.

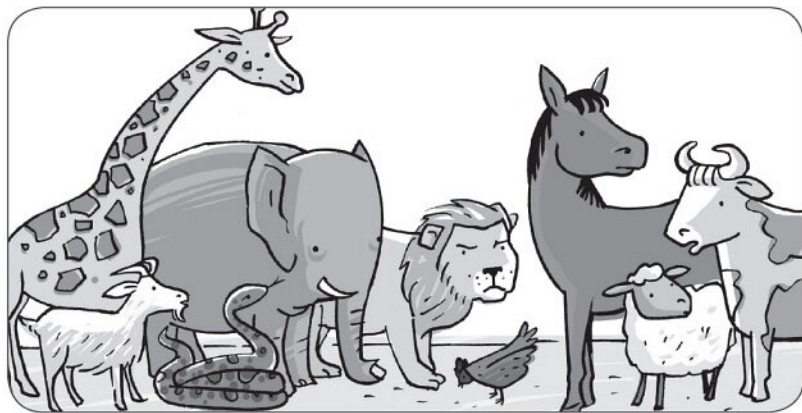

- 1 **Giraffes** / **Goats** are taller than lions.
- 2 **Snakes** / **Cows** are bigger than goats.
- 3 **Hens** / **Elephants** are smaller than sheep.
- 4 **Horses** / **Cows** are faster than sheep.

2 Write.

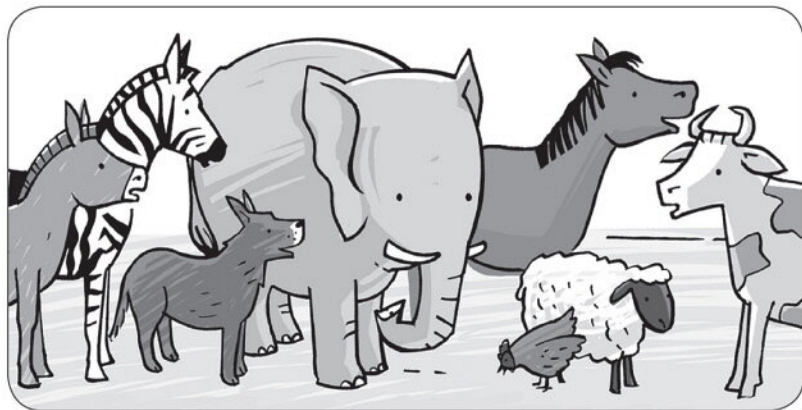

- 1 Zebras are taller (tall) than sheep.
- 2 Elephants are _____ (big) than cows.
- 3 Hens are _____ (small) than dogs.
- 4 Horses are _____ (big) than donkeys.

3 Write *was* or *were*.

Yesterday, James and Polly ¹ were at the beach with their mum and dad.

It ² _____ sunny. The children ³ _____ very happy.

At twelve o'clock, they ⁴ _____ hungry. Mum ⁵ _____ hot.

She ⁶ _____ thirsty, too. Dad ⁷ _____ tired.

Lesson Three

1 Complete the words.

Twelve months in a year

¹ January _____, ² F _____,
³ March _____ and ⁴ A _____,
⁵ M _____, ⁶ June _____,
⁷ J _____, then ⁸ August _____
and ⁹ S _____,
¹⁰ October _____, ¹¹ N _____
and ¹² D _____,
Twelve months in a year!

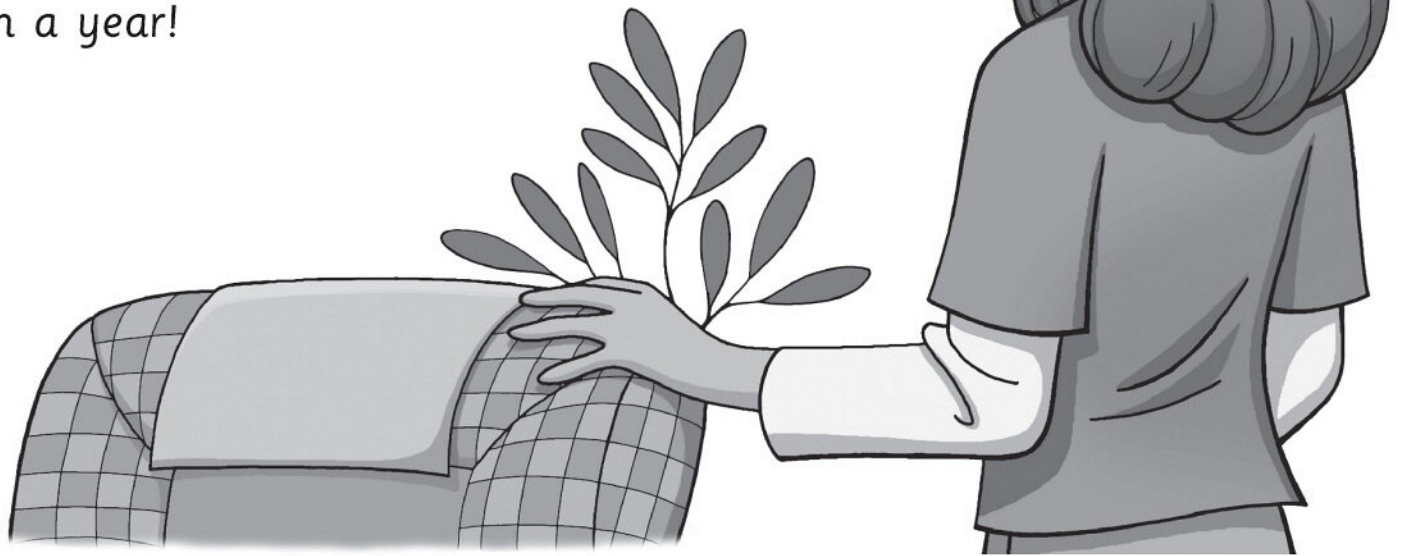
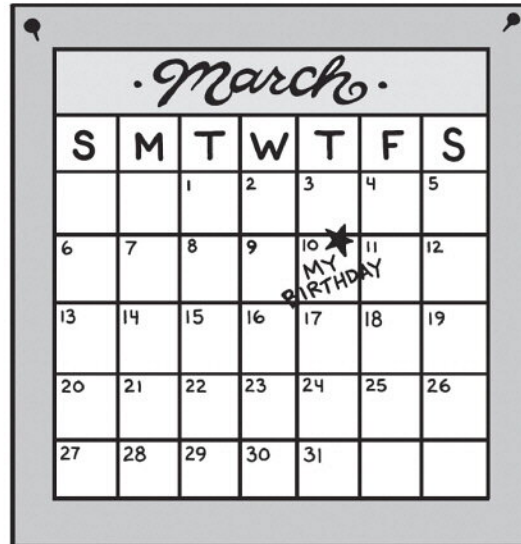

2 Write the next month.

- 1 January, February, _____ March _____
- 2 September, October, _____
- 3 May, June, _____
- 4 December, January, _____
- 5 July, August, _____
- 6 February, March, _____

3 Write about you.

When is your birthday?

How old are you?

When is your mum's birthday?

What is your favourite month?

1 Match.

a **30**

c **50**

e **10**

g **39**

forty-five

thirty a

ten

thirty-nine

fifty

one hundred

sixty

twenty-two

b **100**

d **45**

f **22**

h **60**

2 Write the next number.

1 twenty-one, twenty-two, twenty-three

2 eight, nine, _____

3 thirty-four, thirty-five, _____

4 sixty-seven, sixty-eight, _____

5 thirteen, fourteen, _____

6 ninety-eight, ninety-nine, _____

3 Write in words and complete the sums.

1 $10 + 70 = ?$ ten and seventy is eighty

2 $40 + 50 = ?$ _____

3 $30 + ? = 70$ _____

4 $20 + ? = 100$ _____

5 $60 + ? = 90$ _____

Lesson One Words

1 Write.

Egypt

the UK

Spain

Russia

Thailand

Australia

the USA

Brazil

1



the USA

2

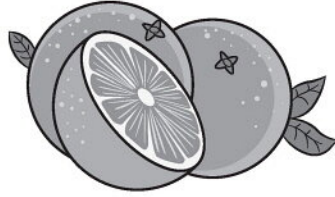

3



4

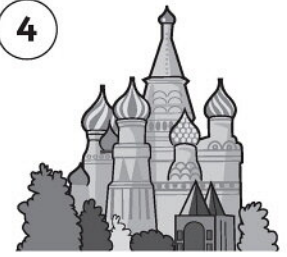

5



6

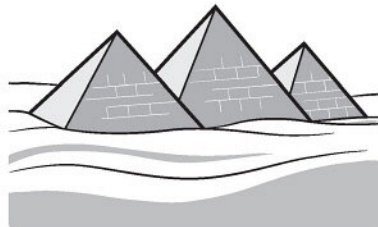

7



8

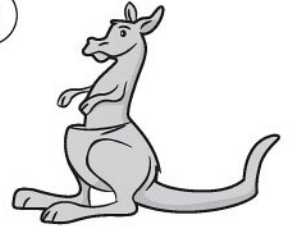

2 Write about you.

My name's _____.

I'm from _____.

1 Tick (✓) the correct sentences.

- | | | |
|----------------------------------|-----------------------|-------------------------------------|
| 1 Lola is eight. | She's from Spain. | <input checked="" type="checkbox"/> |
| | They're from Spain. | <input type="checkbox"/> |
| 2 My name's Sam. | I'm from the USA. | <input type="checkbox"/> |
| | You're from the USA. | <input type="checkbox"/> |
| 3 You and Pedro are friends. | They're from Brazil. | <input type="checkbox"/> |
| | You're from Brazil. | <input type="checkbox"/> |
| 4 Mahmood and Ahmed are cousins. | She's from Egypt. | <input type="checkbox"/> |
| | They're from Egypt. | <input type="checkbox"/> |
| 5 Lee is eight years old. | He's from Thailand. | <input type="checkbox"/> |
| | We're from Thailand. | <input type="checkbox"/> |
| 6 Jenny and I are cousins. | She's from Australia. | <input type="checkbox"/> |
| | We're from Australia. | <input type="checkbox"/> |

2 Order the letters and write the answers.

G Grammar Time! page 124



s a R u s i



y g t p E



l i B z r a



a p S i n

1 Read and write.



1 Jane is eight. She's from the UK.

2 Tom is _____. He's from Australia.

3 Ellie is nine. She's from _____.

4 Carl is _____. He's from the USA.

5 Lisa is _____. She's from the UK.

6 Jack is ten. He's from _____.

2 Write about you and your friends.

I'm _____ . I'm from _____ .
 _____ is _____ .
 _____ is _____ .

3 Write.

from I'm He's It's ~~are you~~ meet you are

Where are you from?



Where ¹ are you from?

² _____ from the UK.

Hello, hello,

How are ³ _____ today?

This is my friend.

⁴ _____ from the USA.

Hello, hello,

How ⁵ _____ you today?

I'm ⁶ _____ Brazil.

⁷ _____ nice to meet you!

Hello, hello,

Nice to ⁸ _____ you, too.

1 Complete the words.

cr dr sp sn pl

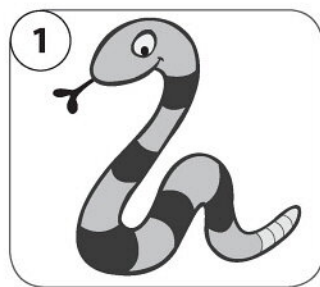

snake

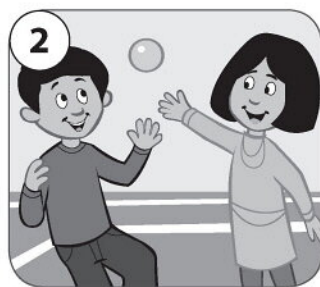

ay

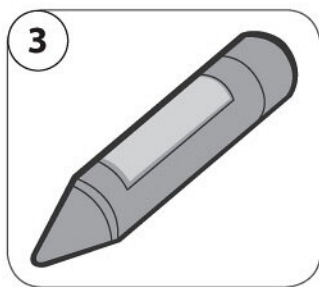

ayon



ink



oon

2 Match the sound with the correct picture. Circle.

1 dr



2 sn



3 cr

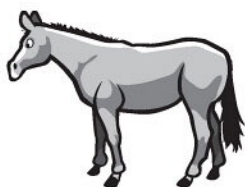

4 sp



5 pl



3 Write.

draw play drink crayon spoon



We ¹ drink from a cup.

We eat with a ² .

We ³ with a

⁴ .

We ⁵ all afternoon.



Skills Time!

Lesson Five

Reading

1 Complete the words. Number the words to match the pictures.

4 g a r d e n

w _ _ _ _ r

_ _ r _ _ g

s _ _ _ o _

_ _ m m _ _

_ _ t _ m _

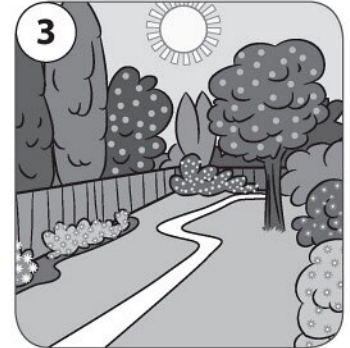
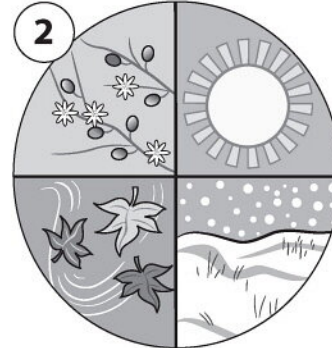

2 Match the sentences with the pictures. Write *a* or *b*.



- 1 Bruno the bear isn't awake.
- 2 The other animals are asleep.
- 3 The animals are awake, but where's Bruno?
- 4 Bruno isn't happy because he's alone.
- 5 Bruno isn't in his home.
- 6 It's hot and there are lots of flowers.
- 7 It isn't warm and sunny.
- 8 The animals are happy because it's summer.

 b

Writing

1 Write the questions with capital letters. Then answer the questions.

1 is leo from egypt?

Is Leo from Egypt? No, he isn't.

2 are you from the usa?

3 is your birthday in august?

4 is holly from australia?

5 is your family from spain?

6 is your birthday in june?



My writing

2 Choose and write.



My name is Katya. I'm from _____ (**the UK / the USA**).

I'm ten. My favourite season is _____ (**autumn / spring**).



My name is _____ (**Brett / Greg**). I'm from Australia.

I'm _____ (**eight / nine**). My favourite season is summer.

3 Write about you.

My name _____ . I'm _____ .

I'm _____ . My _____ .

_____ .

Lesson One Words

1 Number the picture.



- 1 fish
- 2 skateboard
- 3 take photos
- 4 play chess
- 5 read comics
- 6 play basketball
- 7 do gymnastics
- 8 play volleyball

2 Write.



They play chess every day.



_____ in the park.



_____ of their friends.



_____ in the evenings.

1 Read and write T (true) or F (false). **G** Grammar Time! page 124



2 Write. **G** Grammar Time! page 124



1 Match the questions and the answers.

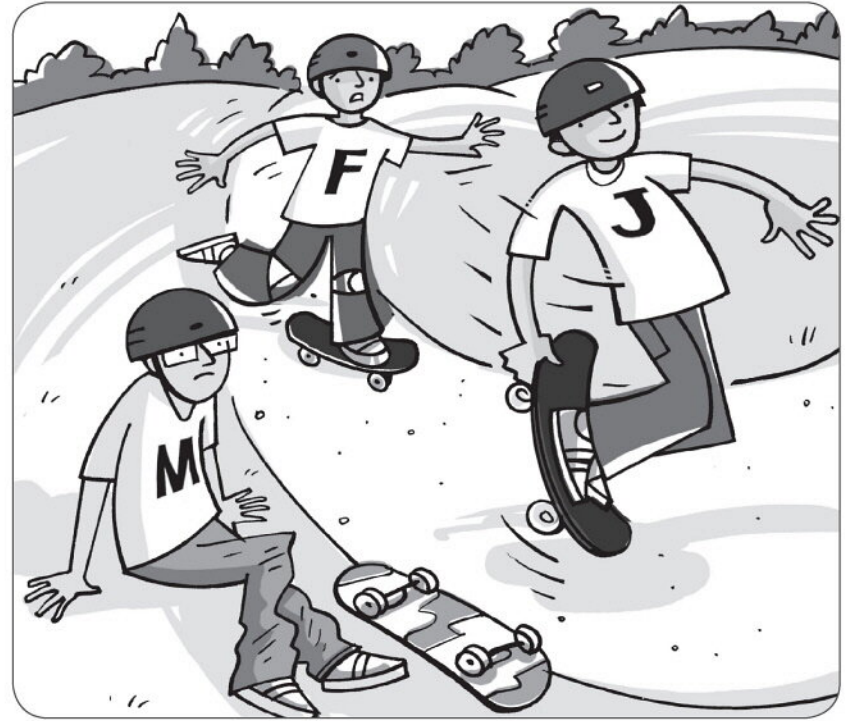

1 Do Max and Jerry like fishing?

d

a Yes, he does.

2 Does Fred like fishing?

b No, they don't.

3 Do Fred and Max like skateboarding?

c No, he doesn't.

4 Does Jerry like skateboarding?

d Yes, they do.

2 Write about you. Complete the questions and circle your answers.

1 Do you like reading comics?

Yes, I do. / No, I don't.

2 Do you like climbing?

Yes, I do. / No, I don't.

3 Do you _____ gymnastics?

Yes, I do. / No, I don't.

4 Do you _____ chess?

Yes, I do. / No, I don't.

3 Write.

photos I like likes drawing playing we chess

I'm happy it's the weekend!

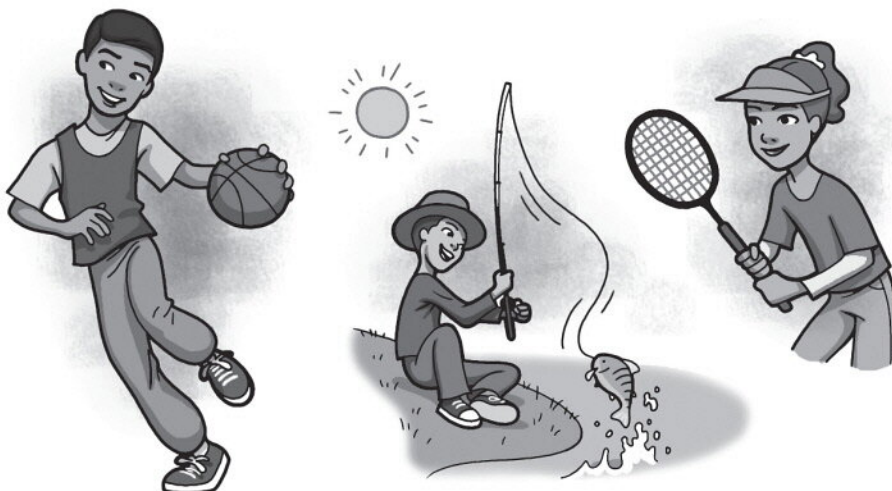

Dad ¹ _____ likes _____ playing basketball,

And he likes playing ² _____.

Mum likes ³ _____ tennis,

But I ⁴ _____ fishing best!

Mum likes ⁵ _____ pictures,

And ⁶ _____ like drawing, too.

Dad likes taking ⁷ _____,

So ⁸ _____ 've got lots to do!

1 Circle the two words that sound the same.

1 space cube bike face

3 line flute gate white

5 face nose bone time

2 stone June rope lake

4 home cube plane tube

6 kite race June nine

2 Complete the words.

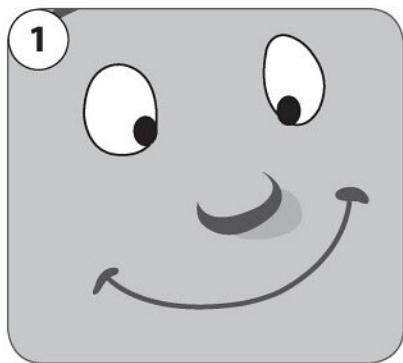

There's a no se on my fac.



I like riding my bike in June.

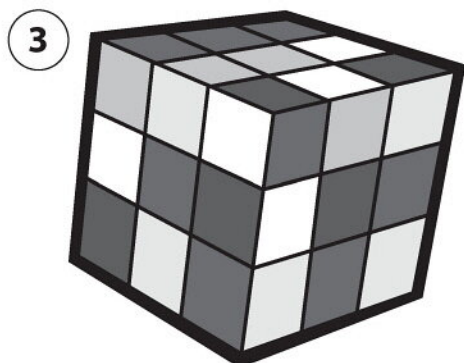

The cube has got six faces.

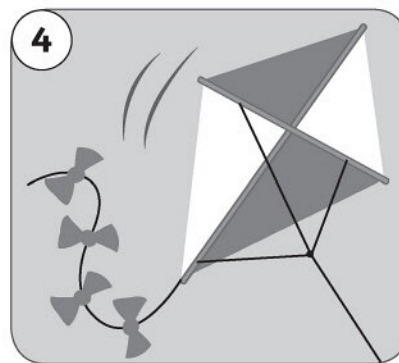

The kite is flying into space.

3 Write.

face cube rope space kite

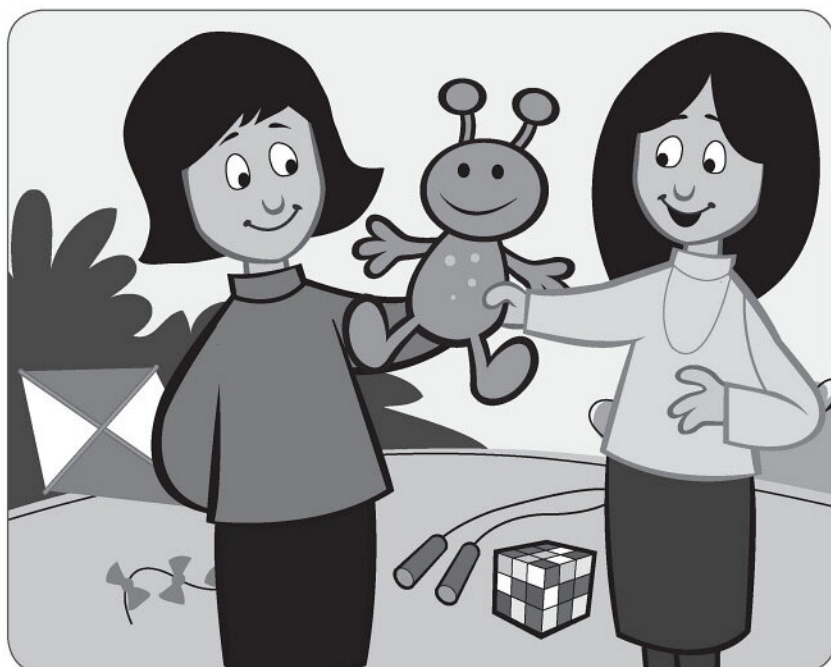

Let's play together, me and you.

I've got a ¹ kite,

And a skipping ², too.

I've got a ³,

And a doll from ⁴.

Look. It's got a purple ⁵.

Skills Time!

Lesson Five

Reading

1 Write.



paint

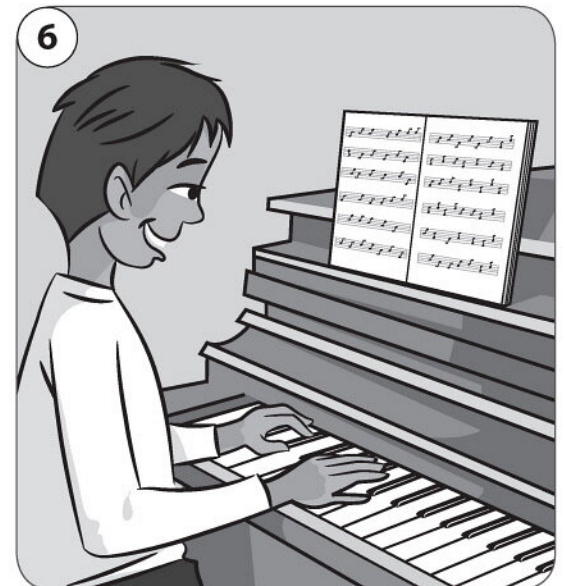

2 Read the Class Book and write *Kelly, Nuria* or *Ismail*.

- | | |
|---|--|
| 1 <u> Kelly </u> 's friends like watching DVDs. | 2 _____ likes playing the guitar. |
| 3 _____ 's friends like listening to music. | 4 _____ likes watching football on TV. |
| 5 _____ doesn't like sports. | 6 _____ 's friend doesn't like basketball. |
| 7 _____ likes playing the piano. | 8 _____ and her friend like dancing. |
| 9 _____ 's sisters love painting pictures. | 10 _____ 's best friend likes volleyball. |

Writing

1 Underline the full forms. Write the short forms.

- | | | | |
|-------------------------------|-------------|----------------------------|-------|
| 1 <u>It is</u> hot in summer. | <u>It's</u> | 2 I have not got a sister. | _____ |
| 3 We are not English. | _____ | 4 I have got two cousins. | _____ |
| 5 She has not got a comic. | _____ | 6 He is from Brazil. | _____ |



My writing

2 Read the Class Book, page 18. Who are these emails for? Circle the correct names. Underline the short forms.

a

Hello **Kelly / Ismail / Nuria!**

My name's Kitty, I'm nine years old and I'm from the USA. I love cooking and I love music. My best friend Rosie and I like playing together – I like playing the guitar, and Rosie plays the piano. We want to play in a band! You also love music, and I want to be your email penfriend. Please write to me.



From Kitty

b

Hi **Kelly / Ismail / Nuria!**

I'm Felipe and I'm nine. I'm from Brazil. I like watching DVDs and listening to music, but I love doing sports! I like playing basketball and I love playing football on the beach with my friends. I'm in my school football team. You like watching football. Do you like playing football, too?



Please email me.

From Felipe

3 Choose a penfriend and write an email.

Hello / Hi _____

My name's / I'm _____

I like _____

I don't like _____

Please _____

Lesson One Words

1 Match.

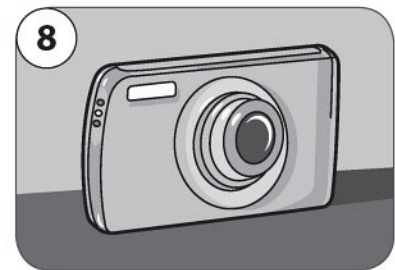
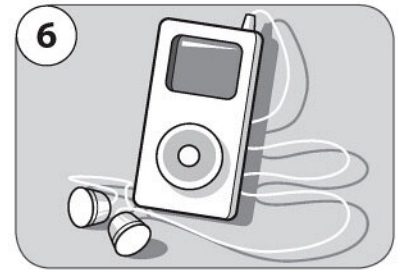
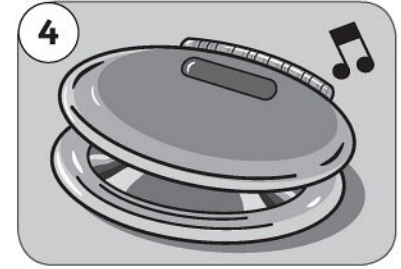
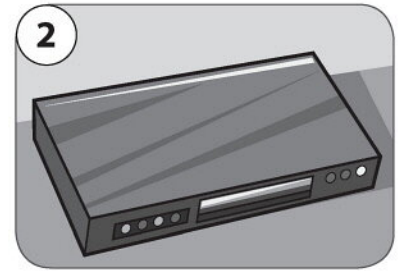
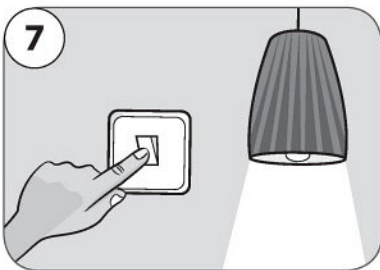
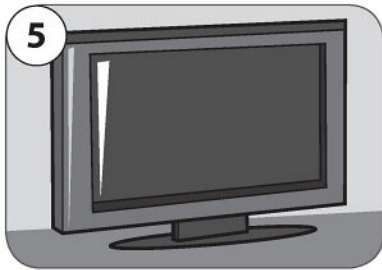
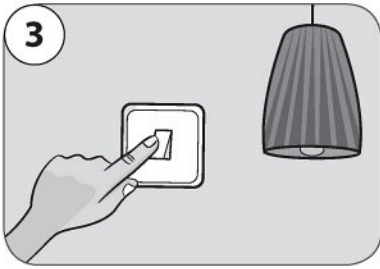

- CD player
- camera
- computer
- turn on
- TV
- DVD player
- MP3 player
- turn off

2 Write.

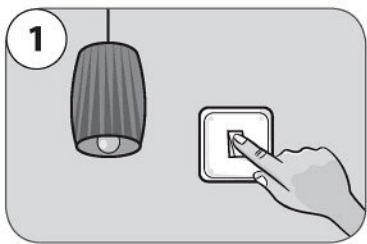

turn off

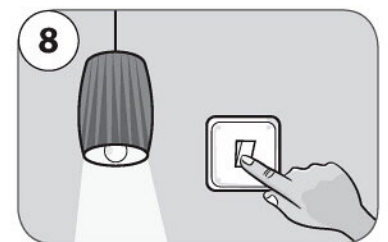
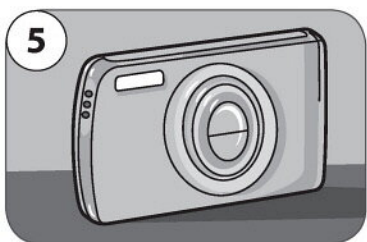

1 Circle *our* or *their*. **G** Grammar Time! page 125



1 **Our / Their** computer is small.

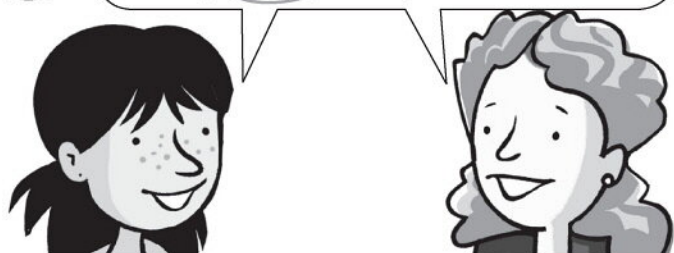

2 **Our / Their** camera is big.

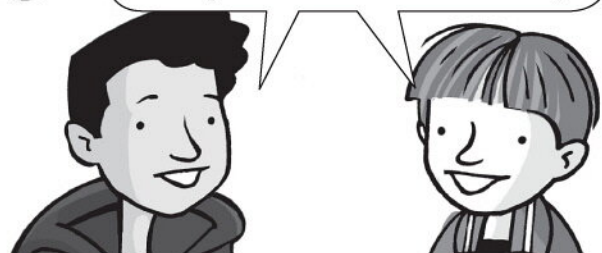

3 **Our / Their** computer is small.

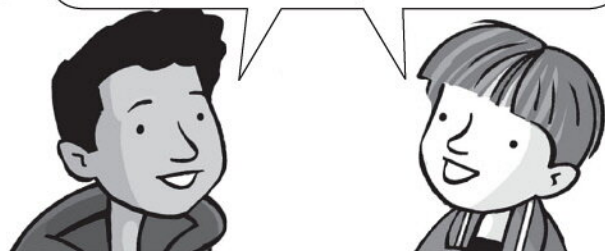

4 **Our / Their** CD player is small.

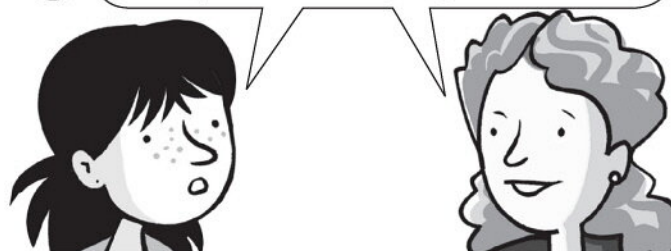

2 Write. **G** Grammar Time! page 126

1 Can I use your camera? (use)



2 Can I _____ ? (watch)



3 _____ (listen)

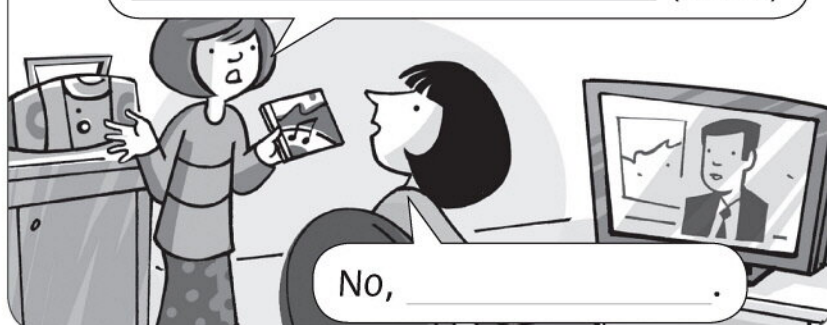

4 _____ (read)



Lesson Three Grammar and Song

1 Write the questions. Grammar Time! page 126

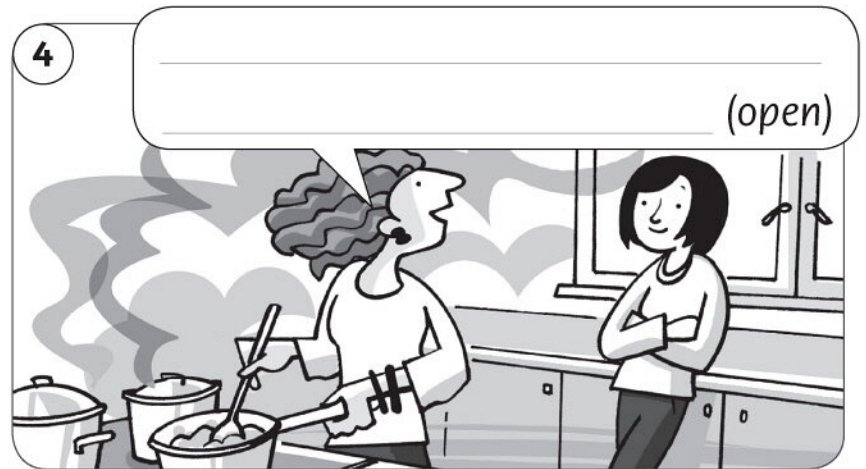
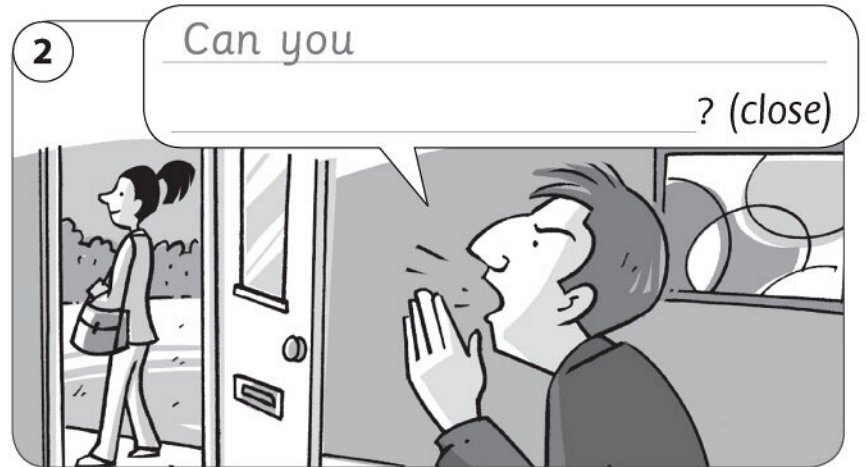

2 Read the song in the Class Book. Write.



It's rainy today

- 1 Can we watch _____ a DVD?
- 2 _____ our new CD?
- 3 _____ TV?
- 4 _____ a show with me?
- 5 _____ out in the sun?
- 6 _____ with me all day?

1 Complete the crossword.

Down ↓

Across →

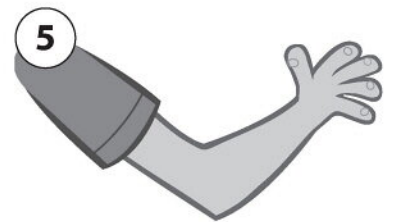
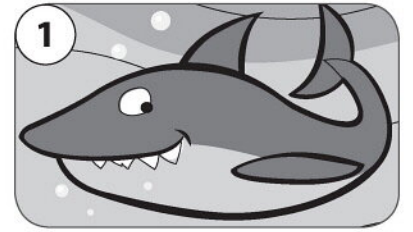
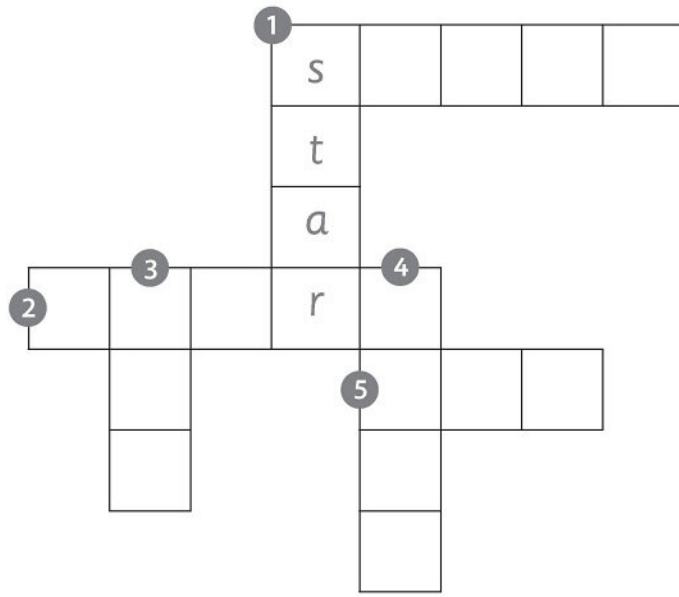
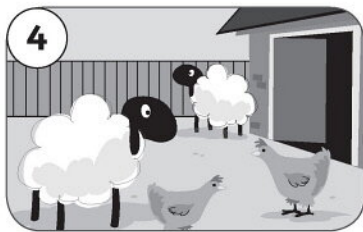
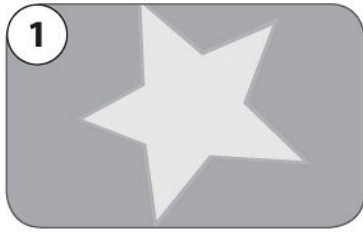

2 Write.

car shark park scarf



We're in the ¹ _____ car _____,
 After playing in the ² _____.
 I've got an orange ³ _____,
 I've got a toy ⁴ _____.

3 Count and write.

- 1 There's one _____ arm _____.
- 2 There are two _____.
- 3 There are three _____.
- 4 There are four _____.
- 5 There are five _____.



Skills Time!

Lesson Five

Reading

1 Count and write.

postcards

posters

badges

shells

~~stickers~~

comics



1 There are six stickers.

2 There are three _____.

3 There are two _____.

4 There are five _____.

5 There are seven _____.

6 There are four _____.

2 Read the text in the Class Book. Circle the wrong words. Write the correct words.

1 Tony has got 60 volleyball stickers.

football

2 He gives his brother some of his stickers.

3 There are 40 badges in Emily's collection.

4 Her badges are on a poster on her bedroom wall.

5 Mark and his sister have got a collection of comics.

6 Their dad buys them two new comics every Monday.

Writing

1 Write sentences. Use capital letters and punctuation marks.



- 1 canyouswitchonthecomputer Can you switch on the computer?
- 2 ilikecookingshoppingandpainting _____
- 3 haveyoutgotacamera _____
- 4 ihavegotacomputeracameraandatv _____



My writing

2 Write the punctuation marks and circle the capital letters.



I've got a collection of postcards ¹ .
 I've got 70 ² . I've got postcards
 from the United States ³ . Spain ⁴ .
 Thailand ⁵ . Australia and from
 my country ⁶ . My favourite
 postcard is from Australia ⁷ .
 It's a kangaroo ⁸ . Have you got
 any postcards ⁹ .

3 This is Tom's collection. Write about it.

He's got a collection of _____ .
 He's got _____ .
 He's got _____ from _____ .
 _____ .
 His favourite _____ .
 _____ .
 It's got pyramids on it.



Everyday English

1 Tick (✓) the correct sentences.

- | | | |
|----------------------------|--|-------------------------------------|
| 1 I love shopping. | So do I. I like cooking, too. | <input checked="" type="checkbox"/> |
| | Neither do I. But I like cooking. | <input type="checkbox"/> |
| 2 I love watching TV. | Neither do I. I prefer reading comics. | <input type="checkbox"/> |
| | I don't. I prefer reading comics. | <input type="checkbox"/> |
| 3 I don't like painting. | So do I. I like drawing, too. | <input type="checkbox"/> |
| | Neither do I. But I like drawing. | <input type="checkbox"/> |
| 4 I love skateboarding. | I don't. I prefer playing volleyball. | <input type="checkbox"/> |
| | Neither do I. I prefer playing volleyball. | <input type="checkbox"/> |
| 5 I like playing football. | Neither do I. But I like playing basketball. | <input type="checkbox"/> |
| | So do I. I like playing basketball, too. | <input type="checkbox"/> |

2 Write. I don't Neither do I So do I I don't

1

I love doing gymnastics.

I don't.

2

I like taking photos.

3

I don't like fishing.

4

I love playing chess.

1 Tick (✓) the correct sentences.

1 Lola is eight.

She's from Spain.

They're from Spain.

2 My name's Sam.

I'm from the USA.

You're from the USA.

3 You and Pedro are friends.

They're from Brazil.

You're from Brazil.

4 Mahmood and Ahmed are cousins.

She's from Egypt.

They're from Egypt.

5 Lee is eight years old.

He's from Thailand.

We're from Thailand.

6 Jenny and I are cousins.

She's from Australia.

We're from Australia.

2 Order the letters and write the answers.

Grammar Time! page 124



s a R u s i



y g t p E



l i B z r a



a p S i n



1 Watch. Who likes each sport? Write *Tom*, *Anna*, *Tom and Anna* or *N* (neither).

1 football _____ *Tom* _____

2 tennis _____

3 skateboarding _____

4 volleyball _____



Tom



Anna

2 What do they say? Match. Then number the pictures in order.

1 I love playing football.

c

a Oh! I don't like tennis.

2 I prefer playing tennis.

b Great! So do I!

3 I don't like skateboarding.

c I don't.

4 I like playing volleyball.

d Neither do I.

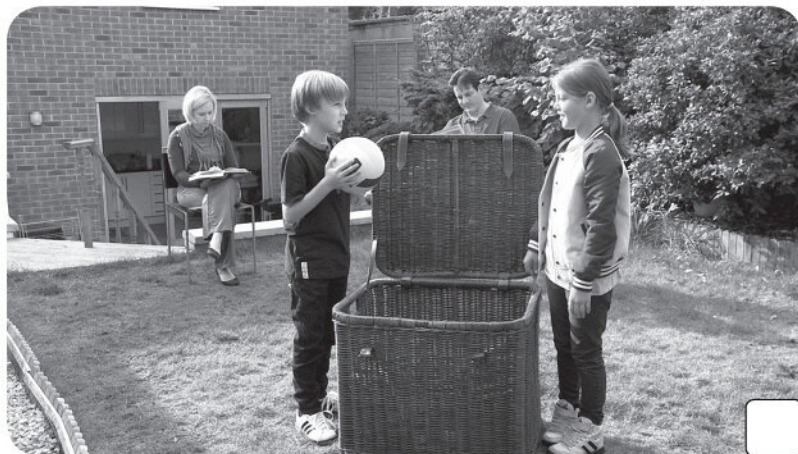

3 What do you like? Talk with your friend. Use the phrases in the box.

I like ... I don't like ... I prefer ... So do I. Neither do I.

1 Write the verbs.

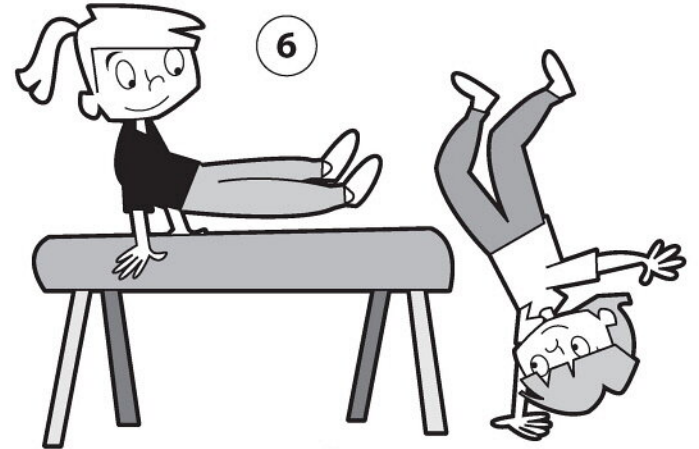
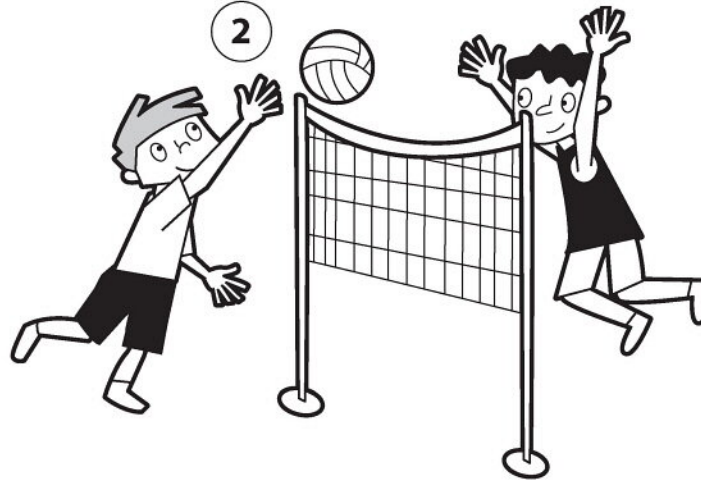

- 1 He likes playing the piano.
- 2 They like _____ volleyball.
- 3 She likes _____ photos.
- 4 She likes _____ fish pie.
- 5 She likes _____ comics.
- 6 They like _____ gymnastics.
- 7 He likes _____ family.

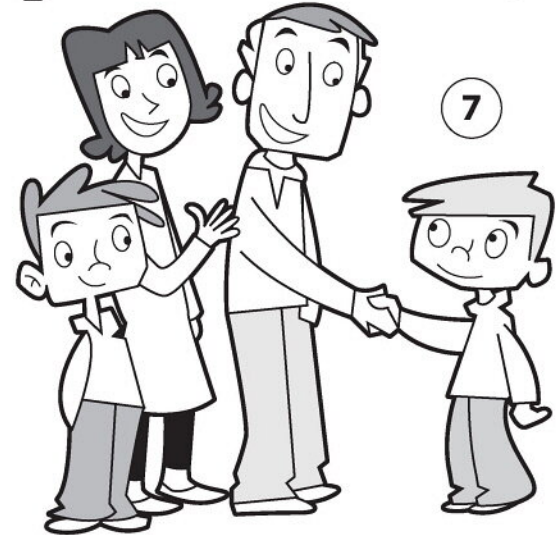

2 Circle the odd one out.

- 1 spring chess winter summer
- 3 cooking fishing autumn painting
- 5 tennis volleyball football season

- 2 DVD player TV MP3 player shopping
- 4 Australia CD player Brazil Egypt
- 6 cooking badges posters stickers

3 Circle the correct words.

- 1 He / I is from the USA.
- 3 Can I / you use your pen, please?
- 5 He / I like cooking.
- 2 She / They doesn't like fishing.
- 4 She / They are from Spain.
- 6 Can I / you help me with my homework?

4 Write *Can I* or *Can you*. Then answer the questions.

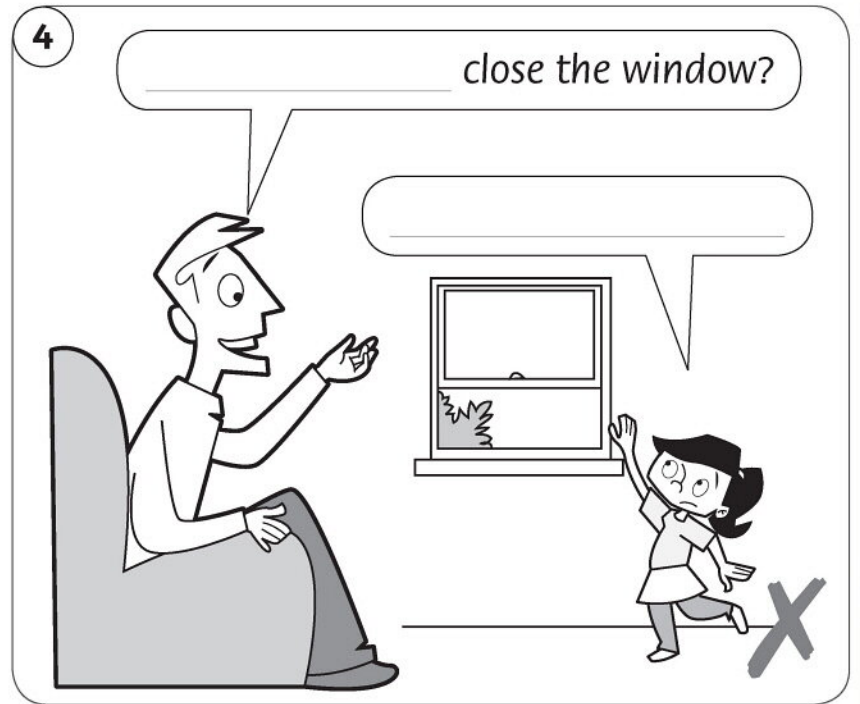
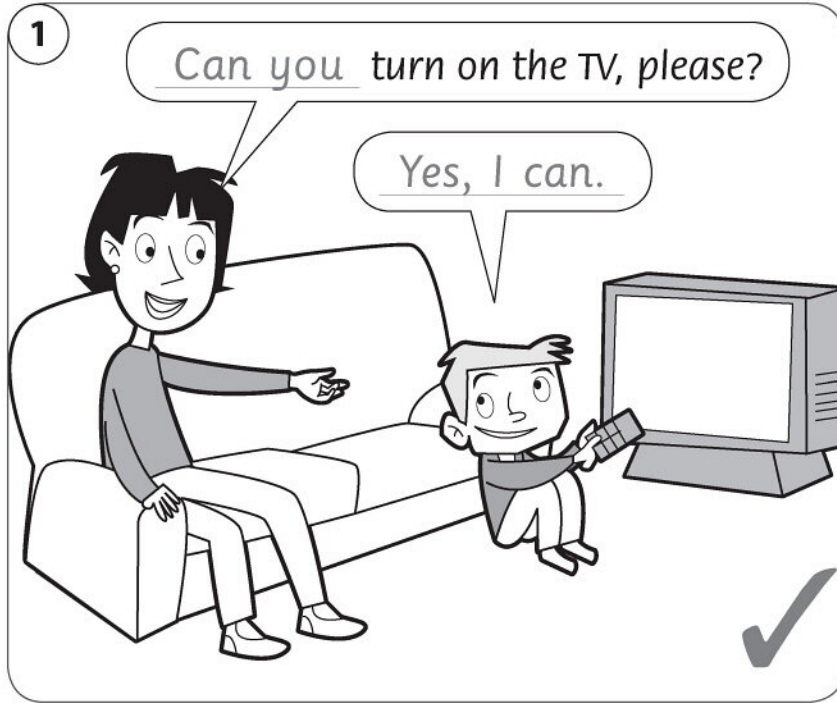

My work

My favourite story in Units 1–3 is _____

My favourite song in Units 1–3 is _____

My favourite unit in Units 1–3 is _____

I need to practise _____

My work in Units 1–3 is



Lesson One Words

1 Number the picture.

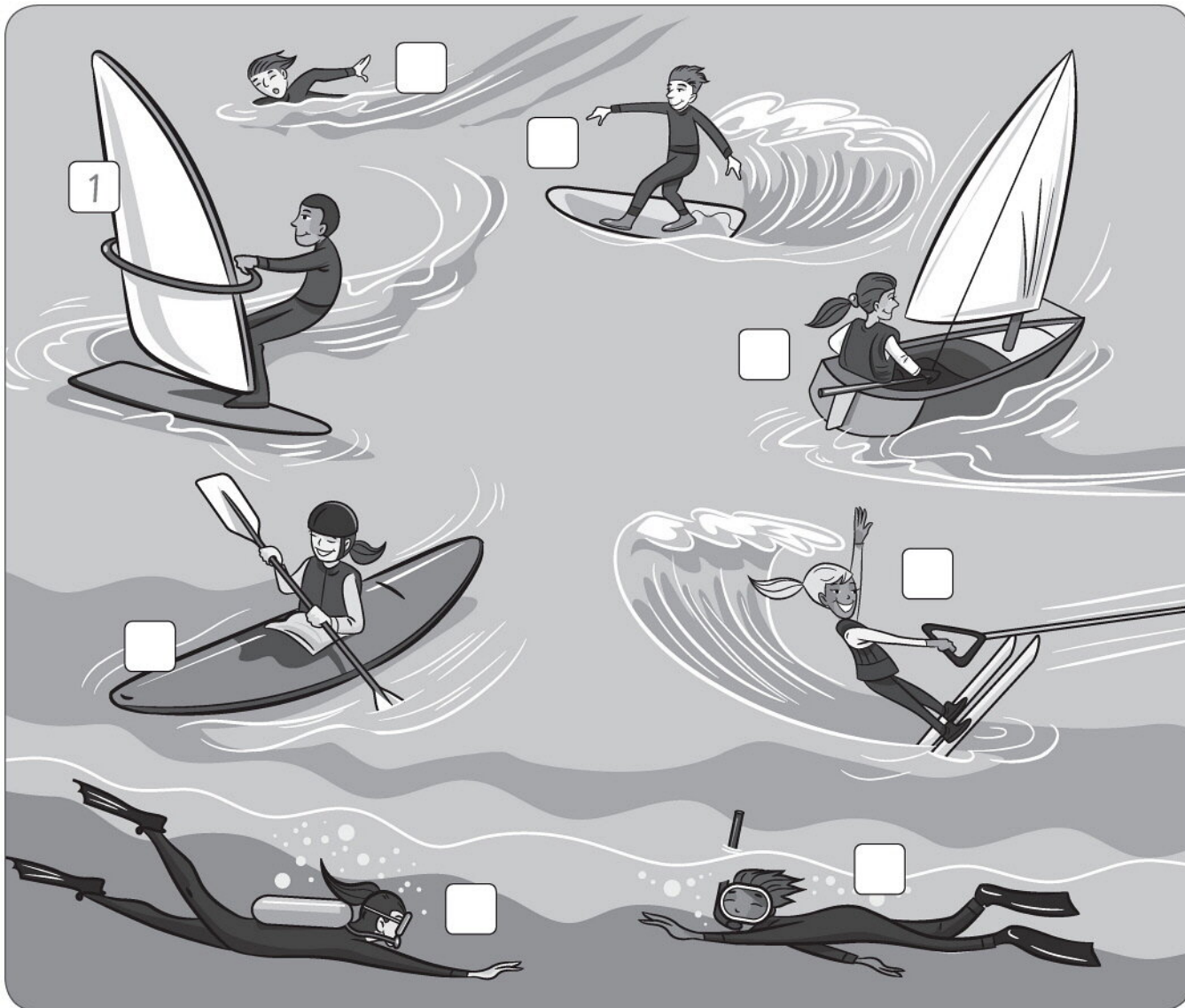

- 1 ~~windsurf~~
- 2 sail
- 3 swim
- 4 kayak
- 5 surf
- 6 waterski
- 7 dive
- 8 snorkel

2 Write.



surf

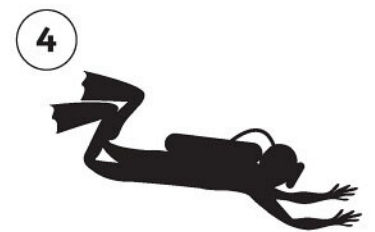

1 Read and tick (✓). **G** Grammar Time! page 126



1 They're sailing.
They aren't sailing.



2 She's surfing.
She isn't surfing.



3 They're kayaking.
They aren't kayaking.



4 He's waterskiing.
He isn't waterskiing.

2 Write. aren't 's 're aren't 'm not 're 'm isn't



1 I'm swimming.
She isn't swimming.



2 We _____ windsurfing.
He _____ windsurfing.



3 I _____ snorkelling.
They _____ snorkelling.

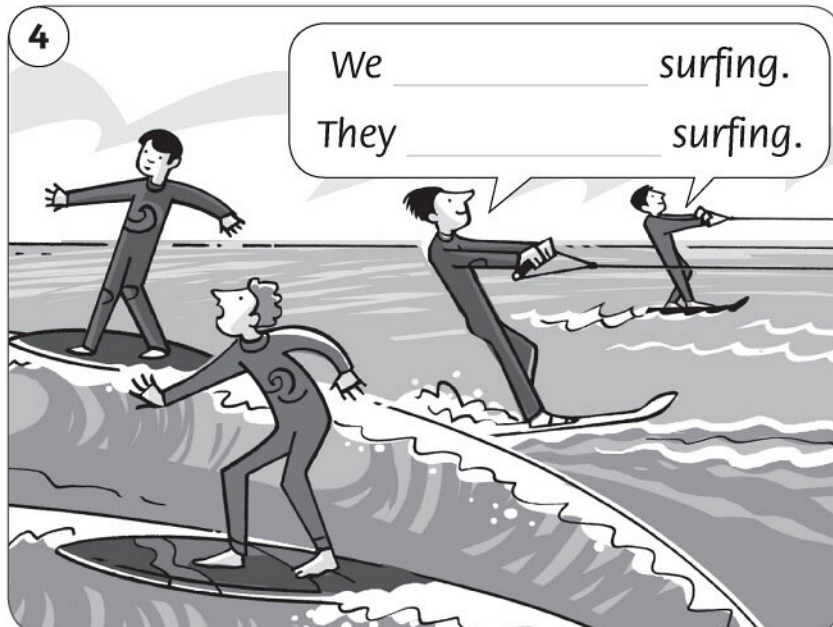

4 We _____ surfing.
They _____ surfing.

1 Match.



- 1 She's listening to music. She isn't drinking a milkshake.
- 2 She's wearing a skirt. She isn't eating a sandwich.
- 3 She's reading a comic. She isn't wearing trousers.
- 4 She's eating a sandwich. She isn't wearing a skirt.
- 5 She's wearing trousers. She isn't reading a comic.

c

2 Read the song in the Class Book. Put the lines in the correct order.

At the beach!



- a We're snorkelling and diving
- b And we can swim and play
- c We're sailing in our little boat
- d We're playing in the sea
- e We're swimming and we're surfing
- f We're playing at the beach today
- g We're having lots of fun
- h We can windsurf at the beach
- i And we're sitting in the sun
- j We all like playing at the beach
- k It's sunny here today
- l There are lots of fish to see

9

 1

 5



1 Complete the words.

b w t sm m

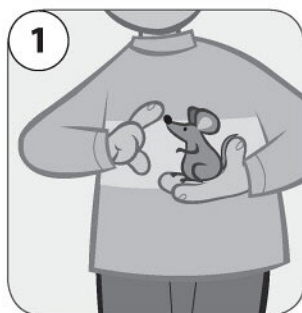

small

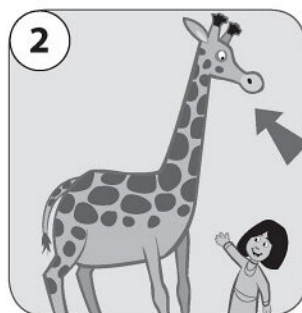

all



all

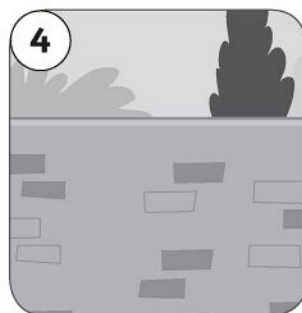

all

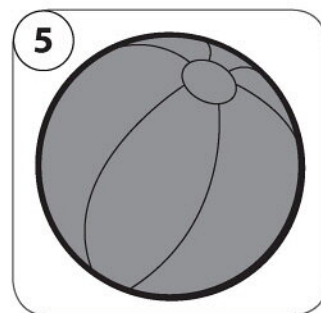

all

2 Write.

small all mall tall ball



I'm in a ¹ mall .
 Some people are ² ,
 Some are ³ .
 I'm going to buy a ⁴ .
 I don't know which to buy.
 I like them ⁵ .

3 Write words with all.

- 1 We go to school all day.
- 2 We buy clothes in the .
- 3 Giraffes are very animals.
- 4 Let's play with a in the park.
- 5 There's a cat on the .
- 6 Australia isn't a country.
- 7 I eat my breakfast.



Skills Time!

Lesson Five

Reading

1 Circle the correct words.



This river is **clean** / **polluted**.



This park is **ugly** / **beautiful**.

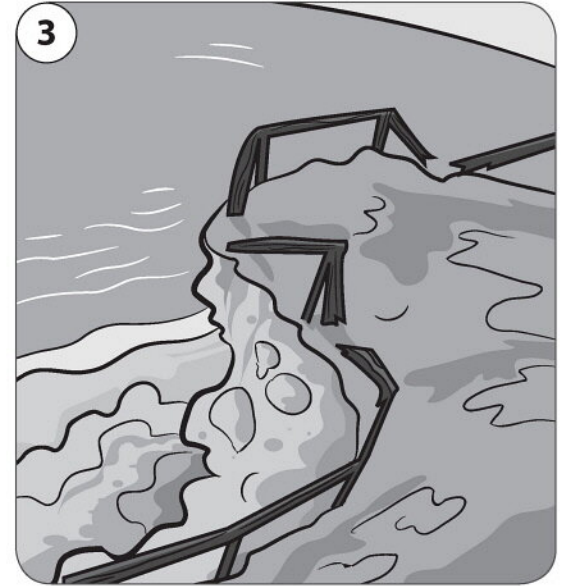

This is **safe** / **dangerous**!

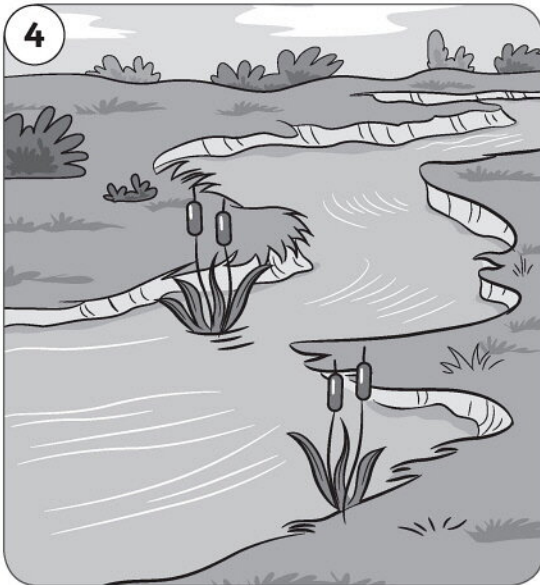

This river is **clean** / **polluted**.

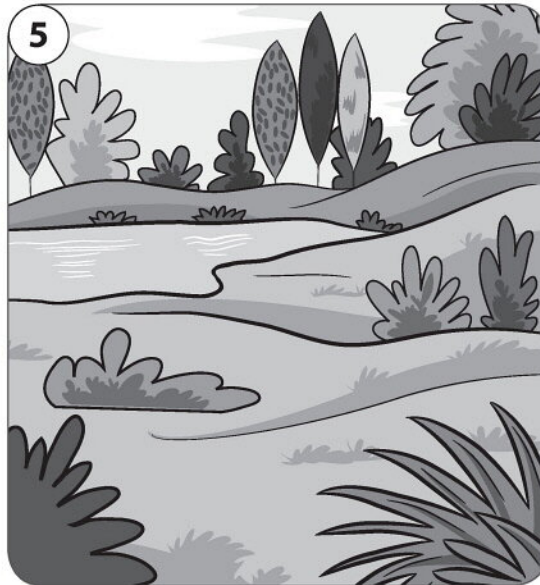

This park is **ugly** / **beautiful**.

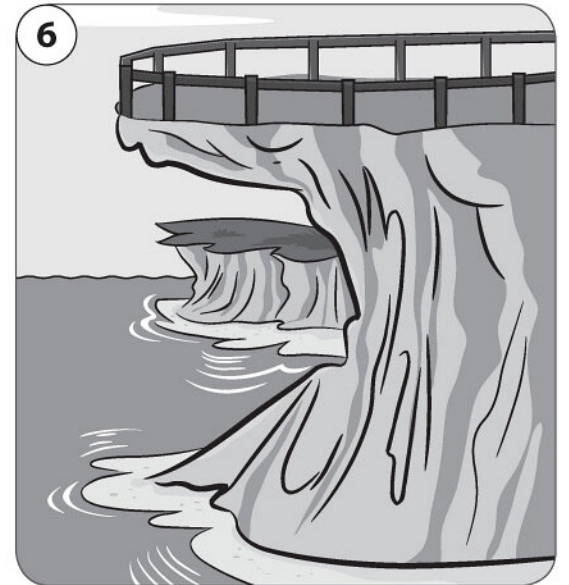

This is **safe** / **dangerous**!

2 Read the text in the Class Book. Write *T* (true) or *F* (false).

- 1 Dolphins live in the sea. T
- 2 They like playing with people.
- 3 Dolphins are dangerous.
- 4 They can breathe under water.
- 5 Dolphins call other dolphins with special sounds.
- 6 They like living in clean water.

Writing

1 Write the verbs. Then answer the questions for you.

Yes, I do. No, I don't.

1 Do you like writing (write) emails? _____

2 Do you like _____ (fly) kites? _____

3 Do you like _____ (watch) TV? _____

4 Do you like _____ (take) photos? _____



My writing

2 Circle the correct words.

We're at the ¹beach / park / zoo.

It is cold and windy.

My grandpa is ²taking / looking
a photo of a lion, my grandma
is ³playing / talking to a monkey
and I'm ⁴writing / watching this
postcard!

From Yolanda



3 Choose a place you like. Write a postcard. Use present continuous verbs.

We're at _____ It is _____

From _____

Lesson One Words

1 Find and circle the animal words. Then write.

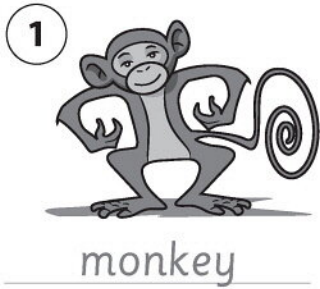

l	h	l	c	a	m	e	l	p	a
i	u	v	m	o	n	k	e	y	j
z	w	k	a	n	g	a	r	o	o
a	f	l	a	m	i	n	g	o	n
r	n	e	p	e	n	g	u	i	n
d	r	u	z	e	b	r	a	m	d
c	r	o	c	o	d	i	l	e	m

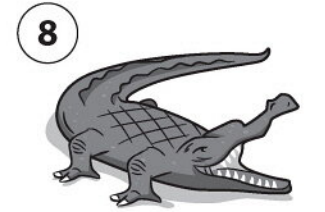
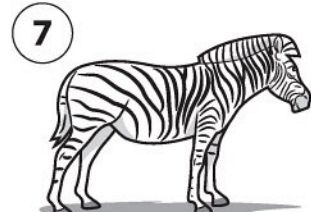

2 Write.



That's not a monkey.
It's a zebra.



That's not a monkey.



That's not a monkey.

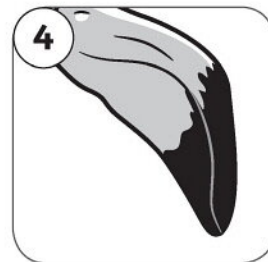

That's not a monkey.

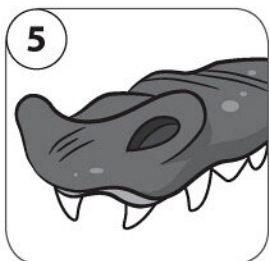

That's not a monkey.

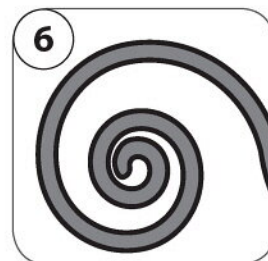

That's a _____ !

1 Read and circle the correct answers. **G** Grammar Time! page 127



- | | |
|--|-----------------------------------|
| 1 Is Dad taking a photo? | Yes, he is. / No, he isn't. |
| 2 Is the crocodile sleeping? | Yes, it is. / No, it isn't. |
| 3 Is the crocodile swimming? | Yes, it is. / No, it isn't. |
| 4 Are the boys looking at the bird? | Yes, they are. / No, they aren't. |
| 5 Are the boys looking at the crocodile? | Yes, they are. / No, they aren't. |
| 6 Is the girl eating an ice cream? | Yes, she is. / No, she isn't. |

2 Write the questions.



(play computer games)



(watch TV)



(listen to music)



(read comics)

1 Look and write. Then answer the questions.

G Grammar Time! page 127

wear a hat write in a notebook eat a sandwich take a photo



Annie

Is Annie wearing a hat?
Yes, she is.



Jo



Liz

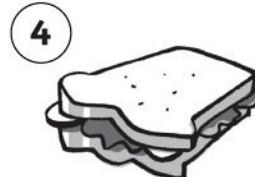

Jo



Annie



Liz

2 Read and write the answers.



1 Are the monkeys eating?

No, they aren't.

2 Are the zebras running?

3 Are the tigers playing?

4 Are the parrots talking?

5 Are the penguins walking?

6 Are the parrots flying?

1 Say the words. Circle the word that doesn't have *or* or *aw*.

- 1 horse corn park fork
 3 fork scarf horse yawn
 5 horse corn car paw

- 2 farm paw yawn straw
 4 corn arm paw straw
 6 yawn straw fork star

2 Complete the words.

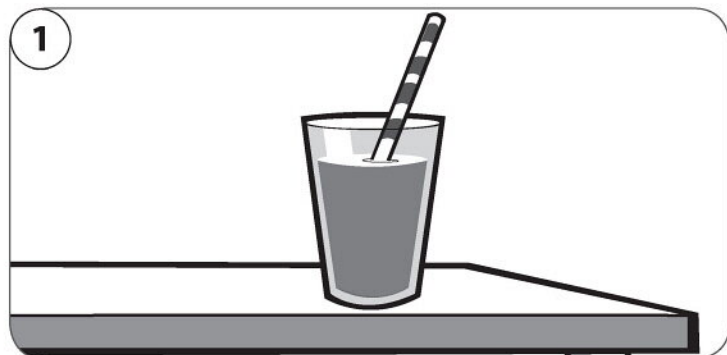

There's a straw in the glass.



I'm eating with a f k.

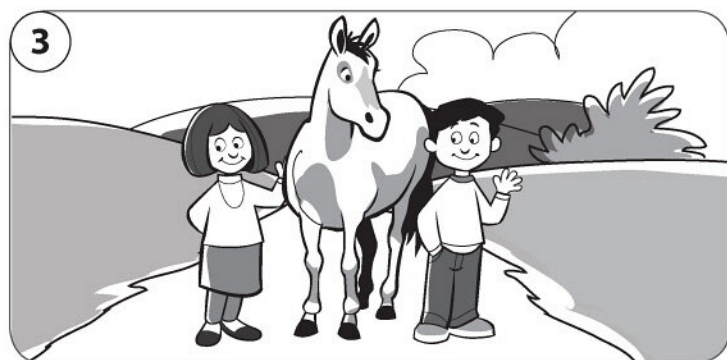

They've got a h se.



Look at the dog's p !

3 Write.

- horse fork ~~straw~~ corn paw



The dog is holding a ¹ straw with its two front ² _____.
 The ³ _____ is holding a ⁴ _____ and it's eating ⁵ _____.

Skills Time!

Lesson Five

Reading

1 Order the letters and write the words.



1

knid kind



2

rsroy



3

efre



4

fnynu



5

esardc



6

rygan

2 Read the text in the Class Book. Put the sentences in the correct order.



- a The lion is angry.
- b A big net falls over the lion.
- c "I'm very sorry," says the mouse.
- d One year later, the lion is walking in the jungle.
- e A mouse runs over the lion's nose and the lion wakes up.
- f The mouse hears the lion and it runs to help.
- g The mouse makes a big hole and the lion is free.
- h A lion is sleeping.
- i The lion opens its mouth and roars.

1

Writing

1 Write the speech marks.

- 1 "Goodbye," says the teacher.
- 2 I'm taking a photo, says the boy.
- 3 Open your books, she says. Read the story.
- 4 The monkeys are my favourite animals, says the girl.



My writing

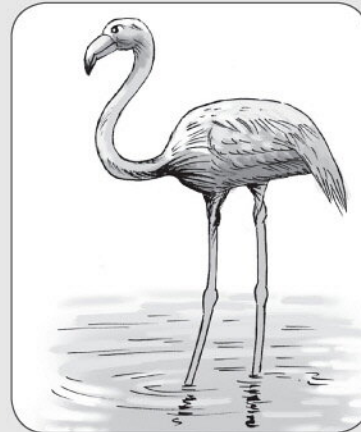
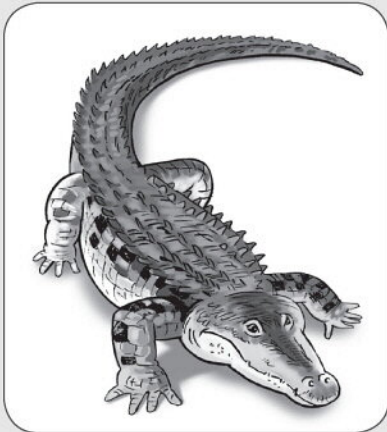

2 Read and write the animal names.

- 1 Flamingos have got long legs. They are pink and white. They can fly. They can swim and run, too. They live near water.
- 2 _____ have got arms and legs. They've got hands and fingers, too. They live and sleep in trees. They can climb and jump.

3 Guess the animals. Write about them. Use the correct punctuation.

- 1 big and tall / brown and red / big feet and big ears / Australia / run and jump

- 2 big and long / in water / swim and walk / dangerous / eat fish

Lesson One Words

1 Match.



- catch the bus
- have breakfast
- get dressed
- brush my hair
- walk to school
- brush my teeth
- get up
- have a shower

2 Write.



Every morning, I get up.



Every _____.



1 Match the questions and answers.



- 1 Does Harry get up early?
- 2 Does Molly brush her teeth?
- 3 Do Harry and Molly have breakfast?
- 4 Does Molly have breakfast with her family?
- 5 Does Harry brush his hair?
- 6 Do Harry and Molly catch the bus to school?

e

- a Yes, she does.
- b No, he doesn't.
- c No, she doesn't.
- d No, they don't.
- e Yes, he does.
- f Yes, they do.

2 Write. **G** Grammar Time! page 128

brush go get up walk brush have breakfast

- 1 Do you go to school?
- 2 _____ your hair?
- 3 _____ your teeth?
- 4 _____ late?
- 5 _____ with your family?
- 6 _____ to school with your friends?

- Yes, I do.
 No, I don't.
 Yes, I do.
 No, I don't.
 Yes, I do.
 No, I don't.



1 Write about Tom.

G Grammar Time! page 127

catch the bus have breakfast ~~get up~~



He doesn't get up at quarter past seven.

He gets up at half past seven.



He _____ at eight o'clock.

He _____ at quarter past eight.



He _____ at half past eight.

He _____ at quarter to nine.

2 Read the song in the Class Book. Write, then put the lines in the correct order.

catch do have get up go ~~have~~ have see

My day

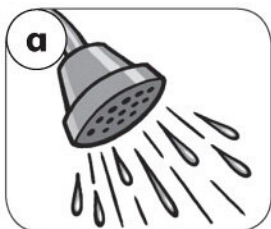

I have a shower every day.



I _____ my school friends every day.

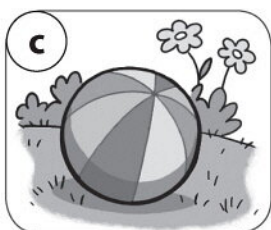

Then I _____ outside and play.



I _____ my lessons every day.

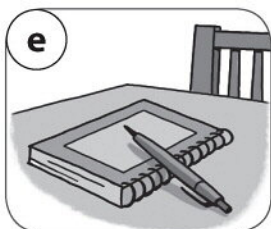

I _____ my homework every day.



I _____ my breakfast every day.



I _____ early every day. 1

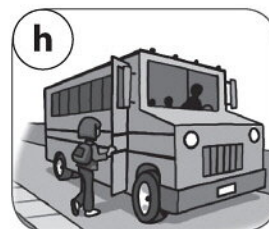

I _____ the school bus every day.

1 Complete the words with *oy* or *oi*.

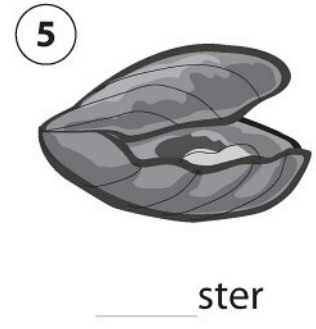
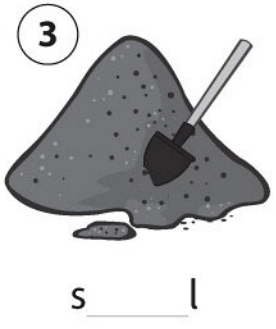
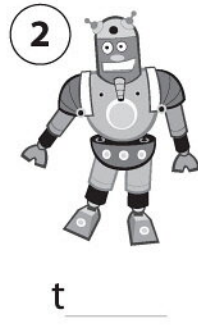

2 Write the words.

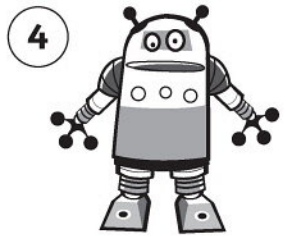
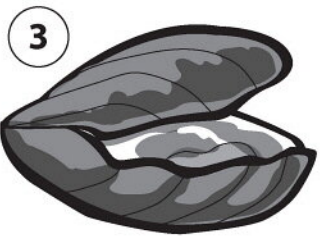

oi

oy

boy

3 Say the words. Circle the word that doesn't have *oy* or *oi*.

- 1 boy toy coin stone
- 3 gate boy oyster oil
- 5 soil white coin oyster

- 2 oil coin coat soil
- 4 boy blue soil toy
- 6 oyster oil boy tube

4 Write. coin boy toy



Roy is a ¹ _____,
 Playing with a ² _____.
 He can see a ³ _____.

Skills Time!

Lesson Five

Reading

1 Read the text in the Class Book. Write.

Finally Next ~~every day~~ First Then at the weekend

- 1 Ellie gets up early every day.
- 2 _____, she helps on the farm.
- 3 _____, she watches her teachers on the Internet.
- 4 _____, she does her school work.
- 5 _____, she sends her work to her teacher by email.
- 6 She doesn't see her friends _____.

2 Write *T* (true) or *F* (false).

- 1 Cyber School students live in Australia. T
- 2 They live a long way from towns and cities.
- 3 They go to school in towns and cities.
- 4 They watch their teachers on the Internet.
- 5 They do their school work with their friends.
- 6 They send their work to their teacher by email.
- 7 They can talk to their friends at school.
- 8 They meet at the weekend and have a sports day.



Writing

1 Write the sentences. Use capital letters and punctuation marks. Remember the proper nouns.

- 1 my favourite film is toy story My favourite film is Toy Story.
- 2 alice lives in paris _____
- 3 mr jones is their teacher _____
- 4 max is amy's cousin _____



My writing

2 Read and circle the proper nouns.

My family



My name is Lucy and I'm nine. There are four people in my family. My brother is called Tim. He is five. My dad is called Steve and my mum is called Jill. We live in a flat near the park.

My favourite things

My favourite day is Thursday because I go swimming every Thursday. My favourite teacher is Miss Wilson. I like lots of films, but my favourite film is Finding Nemo. My favourite month is July because I can play football in the park.



3 Write about the people in your family. Then write about your favourite day, teacher, film and month.

Fluency Time! ②

Everyday English

1 Circle the correct words.

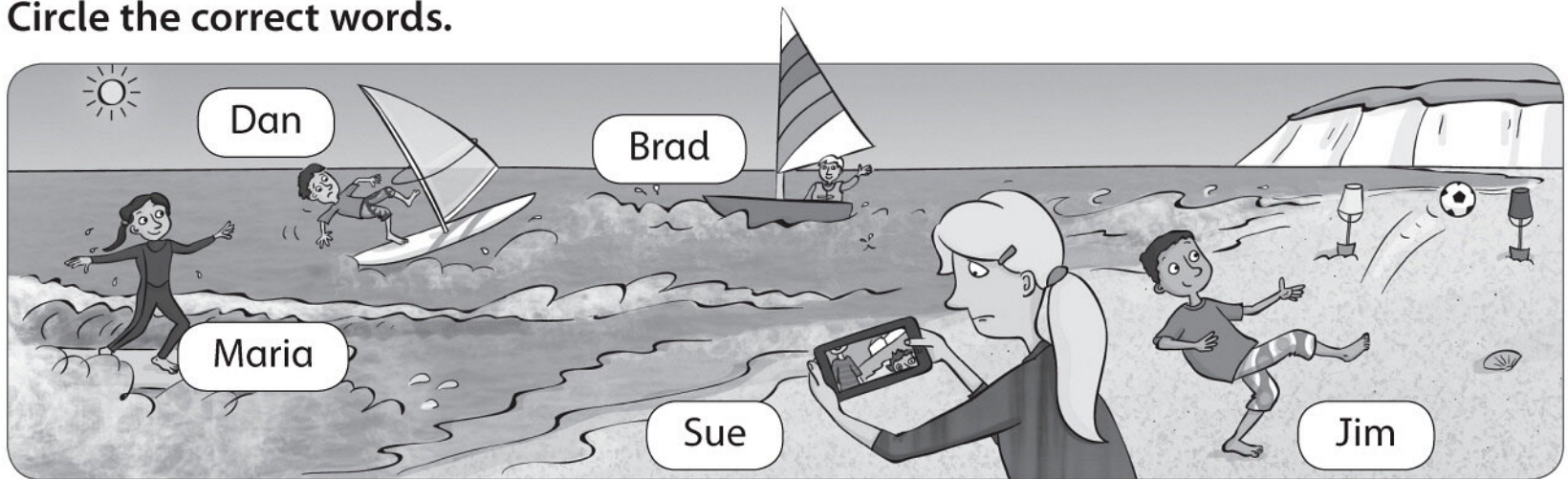

- 1 Are you good at windsurfing, Dan?
- 2 Are you good at surfing, Maria?
- 3 Are you good at taking photos, Sue?
- 4 Are you good at sailing, Brad?
- 5 Are you good at football, Jim?

- No, I'm **good** / **bad** at windsurfing.
- Yes, I'm very **good** / **bad** at surfing.
- No, I'm **good** / **terrible** at taking photos.
- Yes, I'm quite **bad** / **good** at sailing.
- Yes, I'm **good** / **terrible** at football.

2 Write.

terrible quite good ~~bad~~ very good

1



Are you good at painting ?

No, I'm not. I'm bad at painting.



2



Are you good at _____ ?

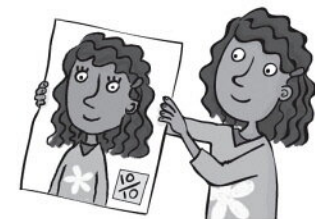

3



Are you _____ ?

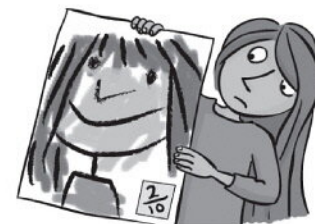

4



Are _____ ?





1 Watch. Who says this? Write *Anna*, *Sam* or *Tom*.



1 Tom

He's quite good at running, too.

2 _____

I'm terrible at throwing!

3 _____

Watch this, Anna!

4 _____

Sam's good at basketball.

5 _____

I'm very bad at basketball.

6 _____

It's my turn now.

2 Complete the descriptions.

kicking

a goal

~~very bad at~~

good at

terrible at



This is Anna.

She's ¹ very bad at _____ basketball.

She's ² _____ throwing!



This is Sam.

He isn't ³ _____ football,

but he's ⁴ _____ the ball now.

He's ⁵ scoring _____.

3 What are you good at? What are you bad at? Ask and answer.

Are you good at running?

Yes, I'm quite good at running.

1 Write the verbs.

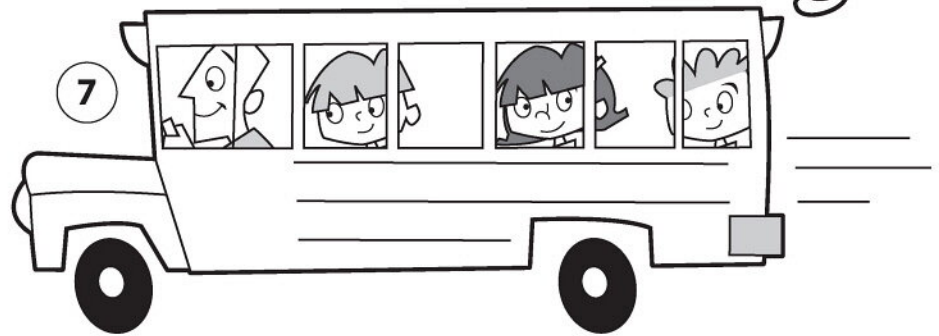

- 1 I have breakfast.
- 2 I _____ my homework.
- 3 I _____ my teeth.
- 4 I _____ to school.
- 5 I _____ dressed.
- 6 I _____ outside.
- 7 I _____ the bus.

2 Circle the odd one out.

- 1 kayak windsurf dive polluted
- 3 sorry free kind water
- 5 beautiful waterski swim snorkel

- 2 safe tall dolphin clean
- 4 first ugly then next
- 6 penguin monkey camel angry

3 Circle the correct words. Then write short answers.

- 1 Is he / I diving? No, he isn't .
- 2 Are I / **they** surfing? Yes, _____ .
- 3 Are **she** / **you and Tim** watching the penguins? No, _____ .
- 4 Does **he** / **they** live in a big house? Yes, _____ .
- 5 Do **she** / **we** get up early? No, _____ .
- 6 Does **she** / **you** have a shower in the morning? Yes, _____ .

Lesson One Words

1 Order the letters and write the words.



1
poshping lalm
shopping mall

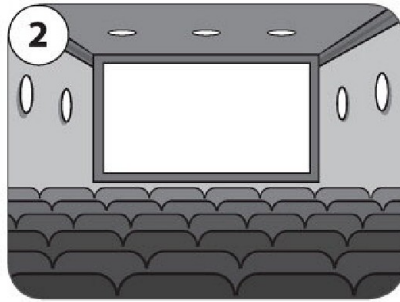

2
ncimae

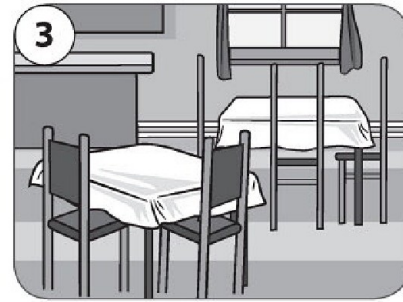

3
fcéa

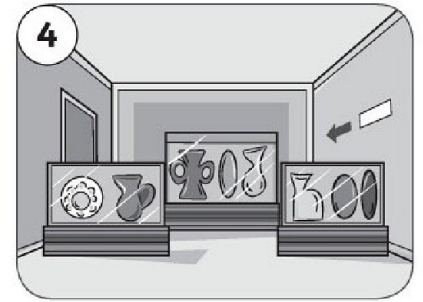

4
smemu



5
rarliby



6
yaplron dgu

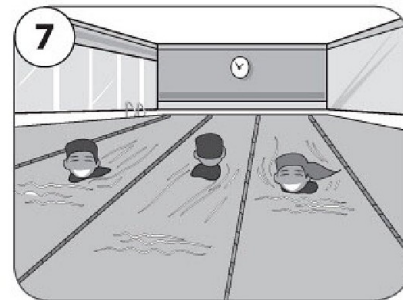

7
snimwigm opol

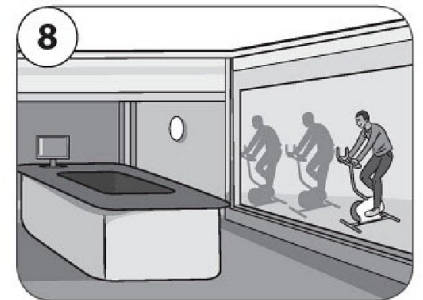

8
trossp etcnre

2 Where are the people? Look and write.

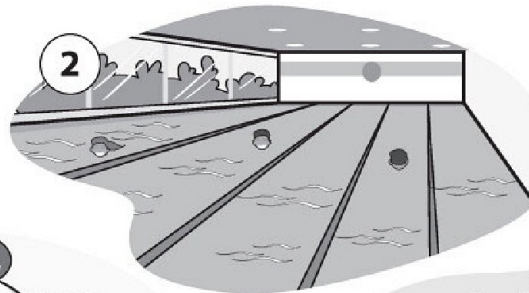

1 They're at the playground.

2 _____

3 _____

4 _____

Lesson One Words

1 Order the letters and write the words.



1
poshping lalm
shopping mall

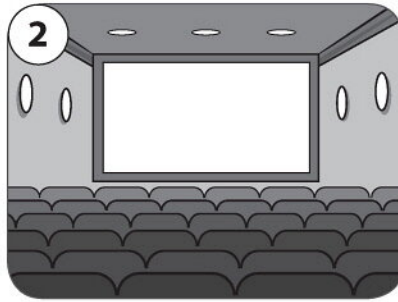

2
ncimae

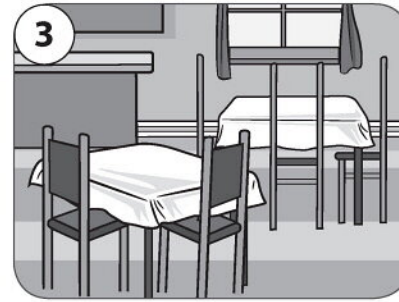

3
fcéa

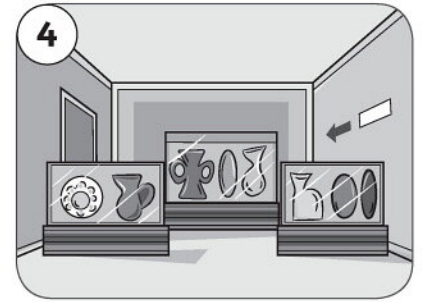

4
smemu



5
rarliby



6
yaplron dgu

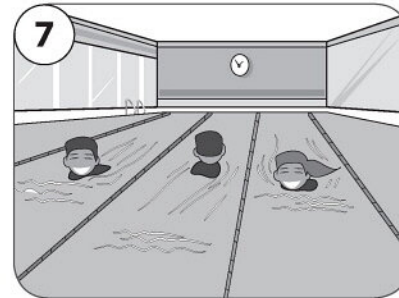

7
snimwigm opol

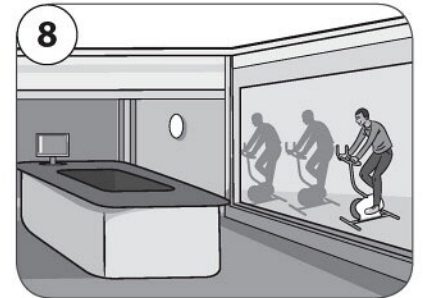

8
trossp etcnre

2 Where are the people? Look and write.

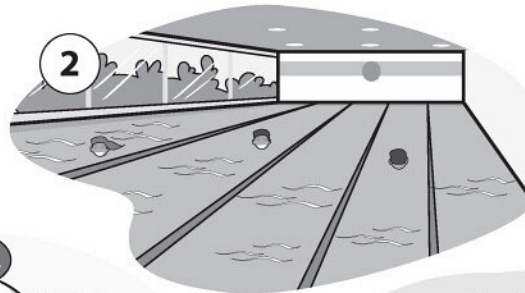

1 They're at the playground.

2 _____

3 _____

4 _____

1 Look at Jane's diary. Circle *never*, *sometimes* or *always*.

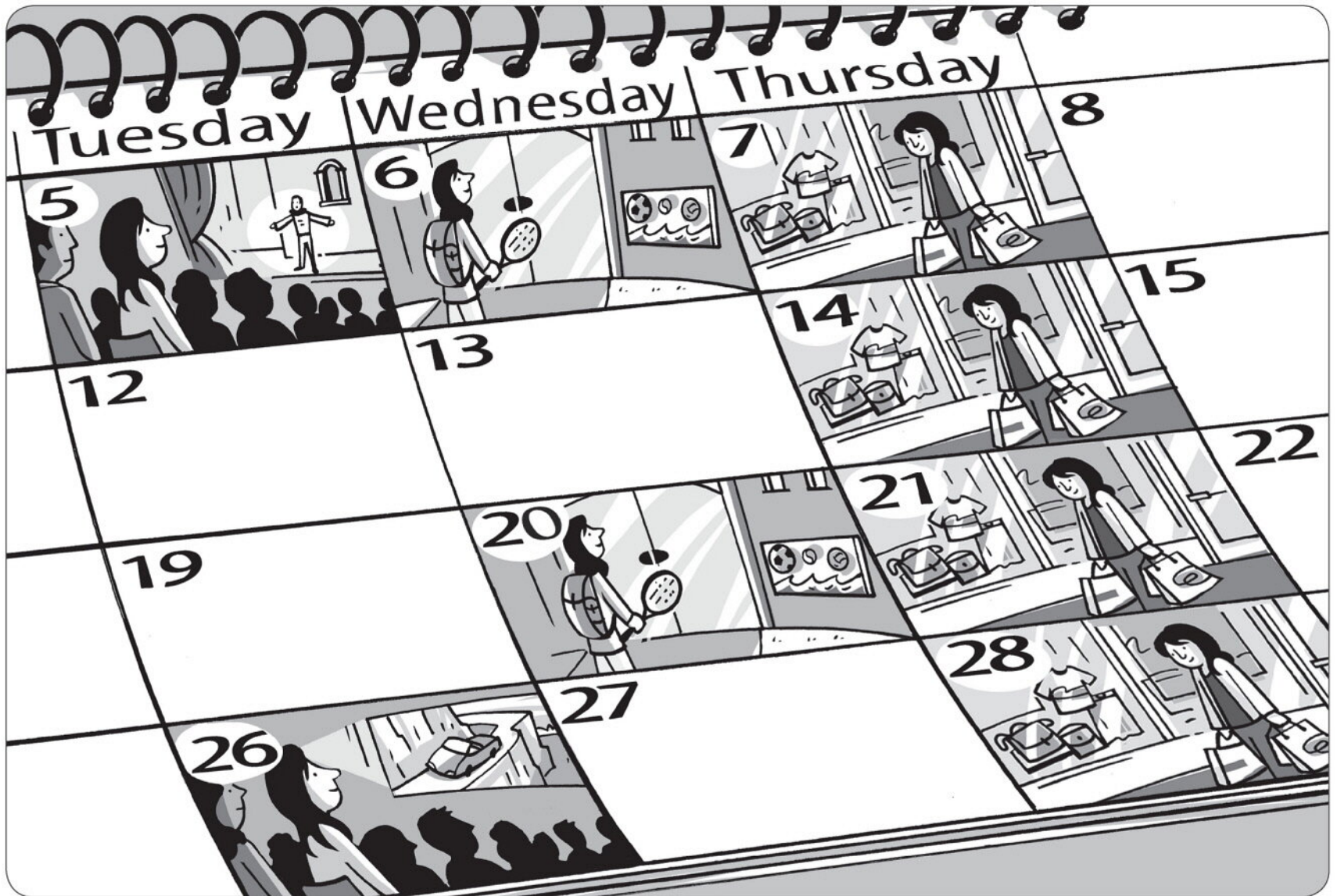

- 1 She never / sometimes / always goes to the cinema on Wednesdays.
- 2 She never / sometimes / always goes to the cinema on Tuesdays.
- 3 She never / sometimes / always goes to the shopping mall on Thursdays.
- 4 She never / sometimes / always goes to the shopping mall on Tuesdays.
- 5 She never / sometimes / always goes to the sports centre on Wednesdays.
- 6 She never / sometimes / always goes to the sports centre on Thursdays.

2 Complete the sentences about Jane with *on*, *at* or *in*.

G Grammar Time! page 128

- 1 She always gets up at eight o'clock.
- 2 She never goes to school _____ Sundays.
- 3 She sometimes visits her cousins _____ July.
- 4 She sometimes goes to bed _____ half past nine.
- 5 She always has a shower _____ Saturdays.
- 6 She never wears a coat _____ August.



Lesson Three Grammar and Song

1 Write.

G Grammar Time! page 128

✓✓ = always

✓ = sometimes

✗ = never

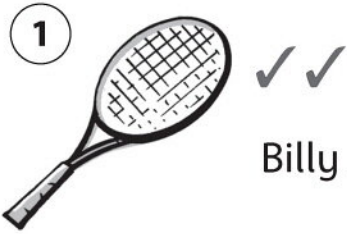

Billy always plays tennis.



Katie _____ football.



Billy _____ basketball.

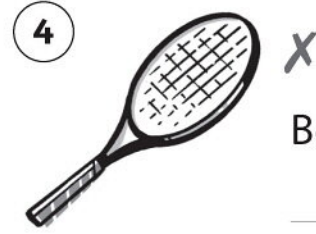

Ben _____

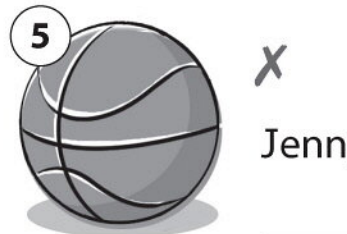

Jenny _____



Ben _____

2 Write true sentences about you. Use *never*, *sometimes* or *always*.

1 I never get up late.

2 _____ my teeth in the morning.

3 _____ breakfast with my family.

4 _____ the bus to school.

5 _____ TV in the evening.

3 Read the song in the Class Book. Tick (✓) the boxes.

**Come and play
with me!**



never	sometimes	always	
	✓		play computer games
			ride my bike
			watch a DVD
			fly my kite
			snorkel in the sea
			read a book
			play my new guitar
			shop
			cook
			surf the Internet
			watch TV
			have a lot of fun

1 Complete the words with *ow* or *ou*. Are the letters the same (S) or different (D)?

- | | | |
|------------------|-------------------|----------|
| 1 d <u>ow</u> n | <u>ou</u> t | <u>D</u> |
| 2 br <u>ou</u> n | fl <u>ow</u> er | <u>S</u> |
| 3 sh <u>ou</u> t | cl <u>ow</u> n | <u>S</u> |
| 4 m <u>ou</u> se | tr <u>ou</u> sers | <u>S</u> |
| 5 c <u>ow</u> | h <u>ou</u> se | <u>S</u> |

2 Write.

house trousers brown mouse flowers ~~clown~~



The ¹ clown 's got ² flowers,
 Red and blue.
 He's wearing ³ trousers ⁴ and a hat,
 But only one shoe.
 He's sitting in his ⁵ house,
 He looks behind a wall.
 He's scared of a ⁶ mouse,
 But it's only small.

3 Write.

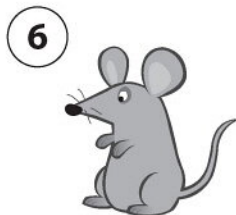
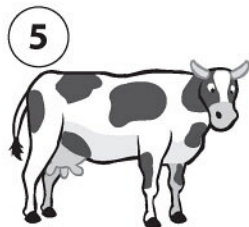
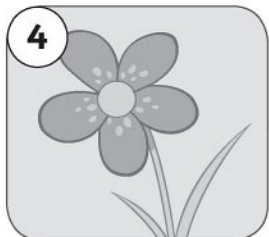
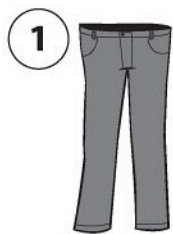

- The boy's wearing a T-shirt and trousers.
- Please come to my house.
- The clown is wearing a hat.
- This is a beautiful flower.
- A cow is bigger than a monkey.
- A mouse is smaller than a horse.

Skills Time!

Lesson Five

Reading

1 Look and write. Find the secret word (↓).

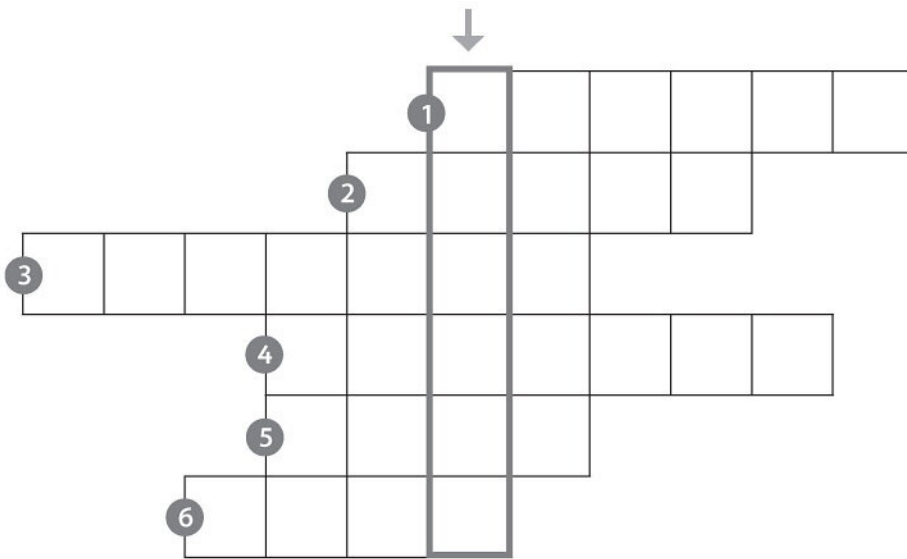

What's the secret word? _____

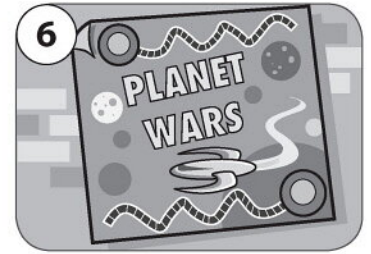
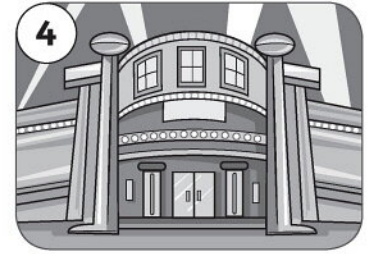

2 Read the Class Book. Order the lines and write the numbers.

- a When Mike is a teenager, he goes to Monsters University.
- b Now the two monsters are friends.
- c Mike and Sulley go to the human world and they can't get back.
- d He meets Sulley at Monsters University, but they are not friends at first.
- e One day, Mike visits Monsters Inc.
- f They get jobs at Monsters Inc. and they have fun working together!
- g Mike and Sulley get home to the monster world.
- h Mike wants to be a scary monster when he grows up.
- i They work together to escape from the human world.

 1

3 Write T (true) or F (false).

- 1 In *Monsters University* there are two worlds.
- 2 The monsters want to be funny.
- 3 Sulley and Mike want to live with humans.
- 4 The monsters can sing really well.

 T

Writing

1 Read and complete the table.

	verb	adjective	preposition
1 Ellie lives on a big farm.	lives		
2 I watch old films on TV.			
3 They're sailing in a little boat.			
4 My new friend often goes to concerts.			



My writing

2 Read and write the names.

Dear Ian,
Do you like the theatre?
Do you want to go on Saturday?
From Mark

Dear ¹ _____,
I can't go to the theatre on Saturday.
I always visit my family at the weekend. Let's go another day.
From ² _____

Hello Sam,
Do you like music? There's a concert at the theatre on Monday.
Do you want to go?
Bye. Katya

Dear ³ _____,
I go to the sports centre on Mondays. I can't go to the concert with you.
From ⁴ _____

3 You are going to the cinema.

Write an invitation. Use these words.

like want go on

Lesson One Words

1 Write.

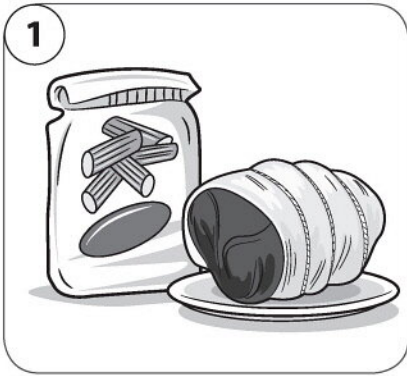

pasta and

meat

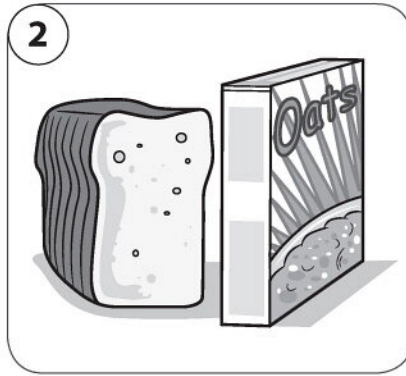

bread and

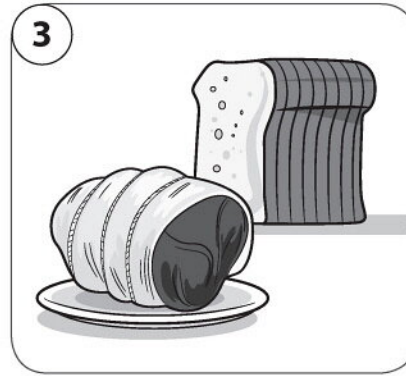

meat and



cereal and

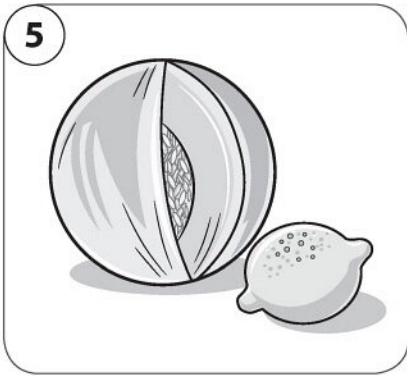

a melon and a

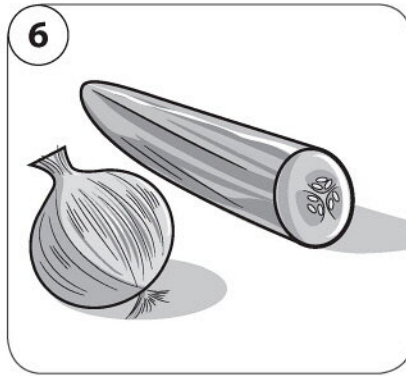

an onion and a

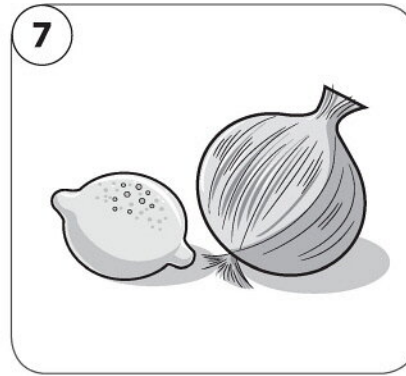

a lemon and an

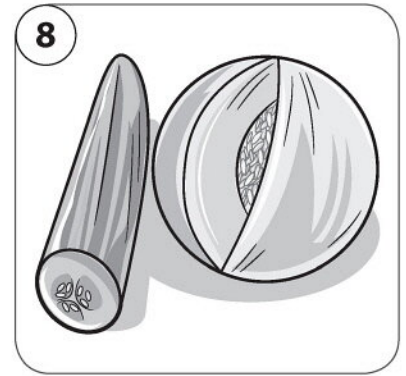

a cucumber and a

2 Look and write a shopping list.

She'd like a cucumber.

She'd like a _____.

She'd like a _____.

She'd like an _____.

She'd like some _____.

She'd like some _____.

She'd like some _____.

She'd like some _____.



1 Write. **G** Grammar Time! page 129

pasta bread apple egg biscuits rice orange fries



1 He'd like some pasta.

2 _____

3 _____

4 _____

5 _____



6 _____



7 _____



8 _____

2 Complete the questions and write the answers.

1   Would you like some water ?  Yes, please.

2   Would you like _____ ?  _____

3   Would you like _____ ?  _____

4   Would you like _____ ?  _____

1 Complete the questions with *a* or *some* and a food word.

1 Would you like some onions , Stacy?

Yes, please.



2 Would you like _____ ?

No, thanks.

3 Would you like _____ , Ollie?

Yes, please.



4 Would you like _____ ?

No, thanks.

5 Would you like _____ , Emma?

Yes, please.



6 Would you like _____ ?

No, thanks.

2 What would you like for dinner? Write *a*, *an* or *some* and food words.

I'd like _____

 _____ for dinner.

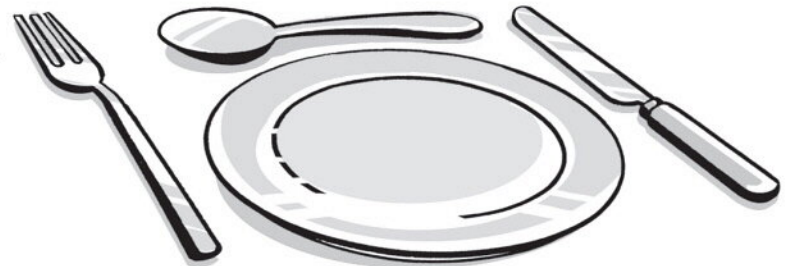

3 Read the song in the Class Book. Put the lines in the correct order.

At the supermarket











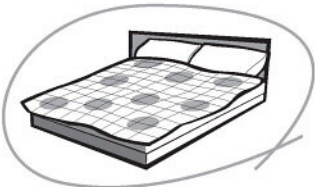

- a We buy things to eat
- b I would like some meat
- c Apples, bread and biscuits
- d I would like a melon
- e They're very fresh and sweet
- f I would like some onions
- g At the supermarket
- h I would like some apples
- i They're healthy and they're nice
- j I would like some lemons
- k Pasta, rice and meat
- l I would like some rice

9

1 Say the words with *ld* and *lt*. Circle the odd one out. Write this word.

adult field child quilt

1				_____ quilt _____
2				_____
3				_____
4				_____

2 Complete the words. Write *T* (true) or *F* (false).

ld lt

- 1 There's a child ld in the bedroom.
- 2 There's a be _____ on the chair.
- 3 There's a qui _____ on the bed.
- 4 There's a shie _____ on the door.
- 5 There are some cows in the fie _____.
- 6 There's an adu _____ in the bedroom.

T



3 Write.

field quilt adult shield



A child and an ¹ adult
 Are standing in a ² _____.
 The adult's got a ³ _____.
 The child's got a ⁴ _____.

Skills Time!

Lesson Five

Reading

1 Circle the words and write.

salt peas cheese potato pepper butter

- 1 _____ peas _____
- 2 _____
- 3 _____
- 4 _____
- 5 _____
- 6 _____

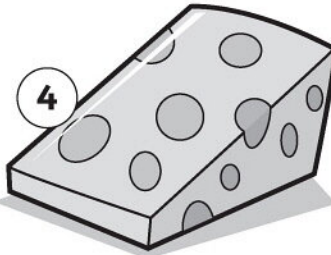
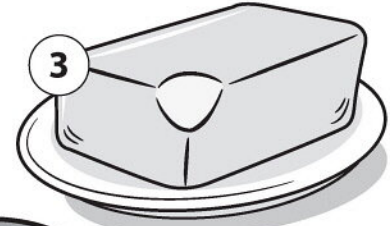
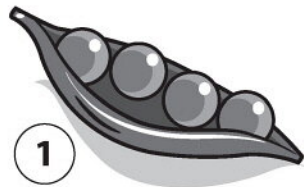

2 Read the text in the Class Book. Write a shopping list for *My Favourite Dish*.

two big potatoes

Writing

1 Order the words and write.

1 He's playing with a small , blue ball .

small ball blue

2 She's wearing _____ , _____ .

pink big sunglasses

3 You need a _____ , _____ .

red onion big

4 He's sailing in a _____ , _____ .

boat little red

5 We'd like a _____ , _____ .

green cucumber long



My writing

2 Complete the instructions.

butter bread grapes cheese

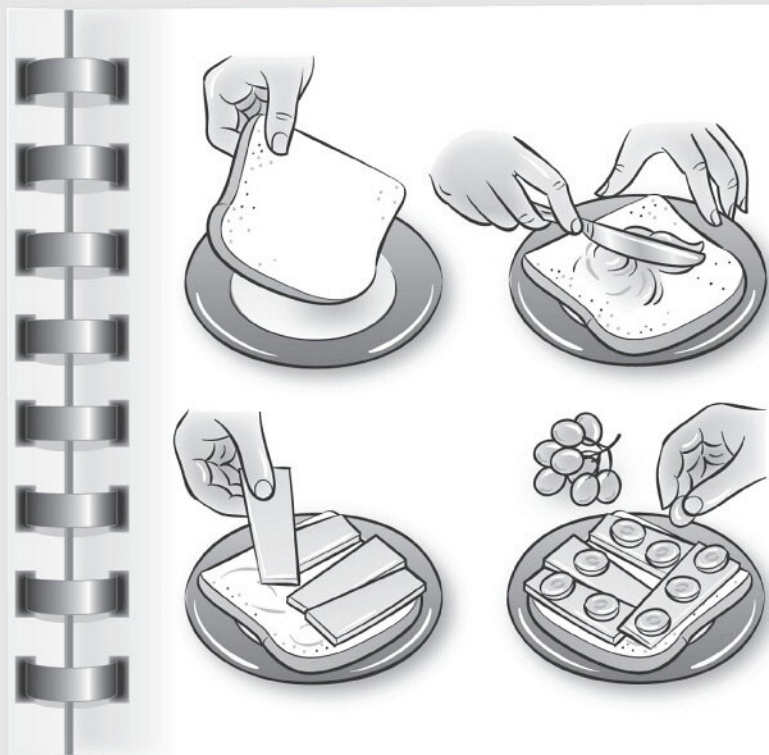

How to make my favourite sandwich

You take some ¹ bread .

You put some ² _____ on the bread.

You take some ³ _____ and you put it on the bread.

Then you take some ⁴ _____ and you put them on top.

This is my favourite sandwich. It's great!

3 Write instructions for making your favourite sandwich.

You take _____

You put _____

Lesson One Words

1 Look and count. Write the numbers.

- 1 There are four lakes.
 2 There are _____ mountains.
 3 There are _____ waterfalls.
 4 There are _____ oceans.

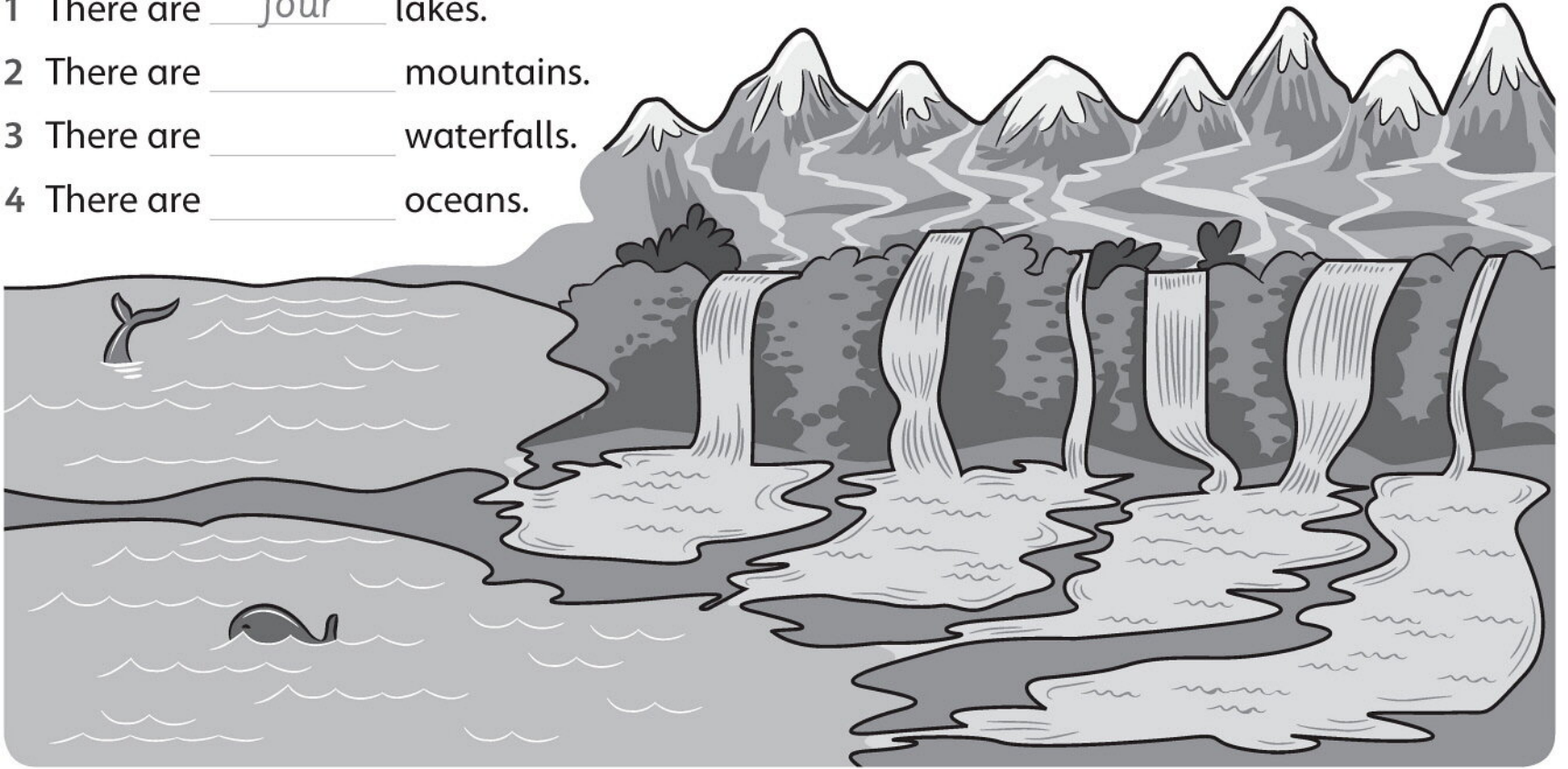

2 Write.

wide waterfall ocean big deep mountain lake high

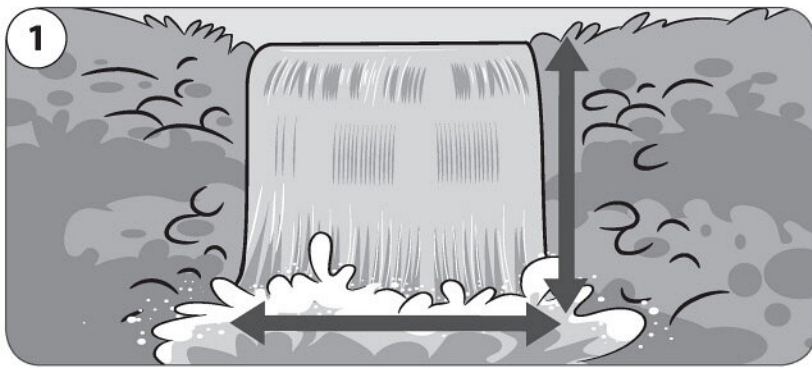

This is a big waterfall.

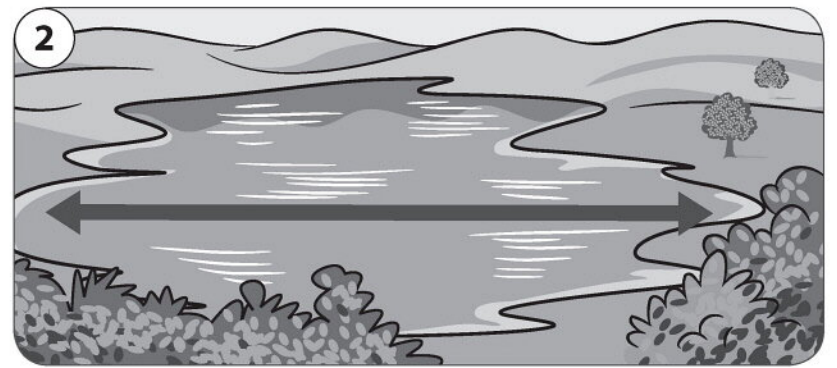

This is a _____.



This is a _____.

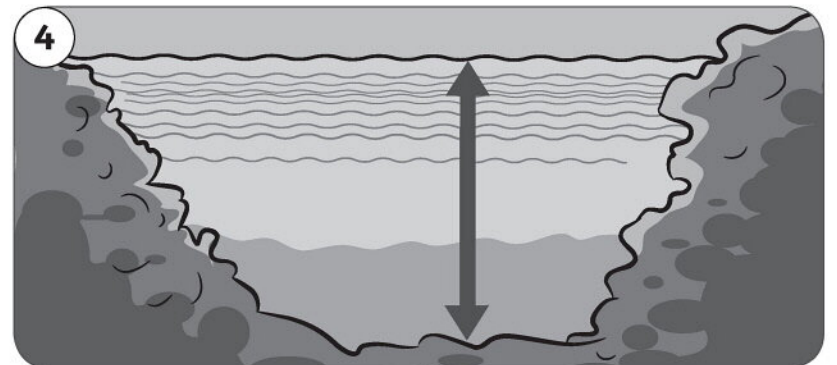

This is a _____.

1 Read and tick (✓) or cross (X) each sentence.

G Grammar Time! page 129

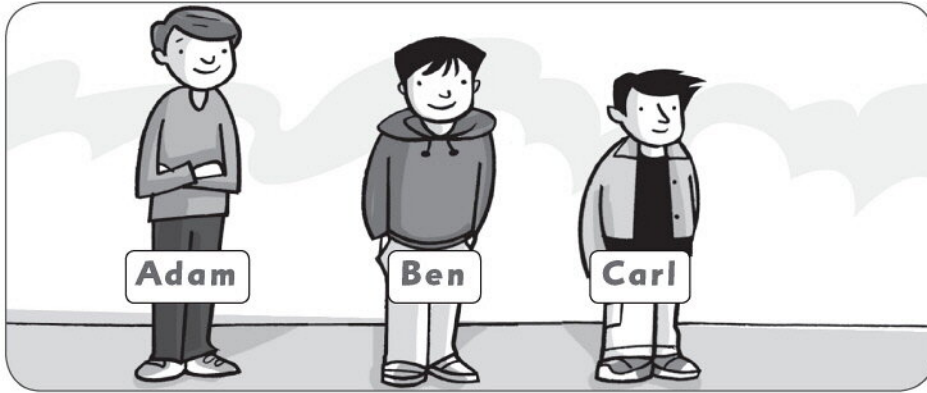

- 1 Ben's taller than Carl.
- 2 Carl's taller than Adam.
- 3 Adam's the tallest.

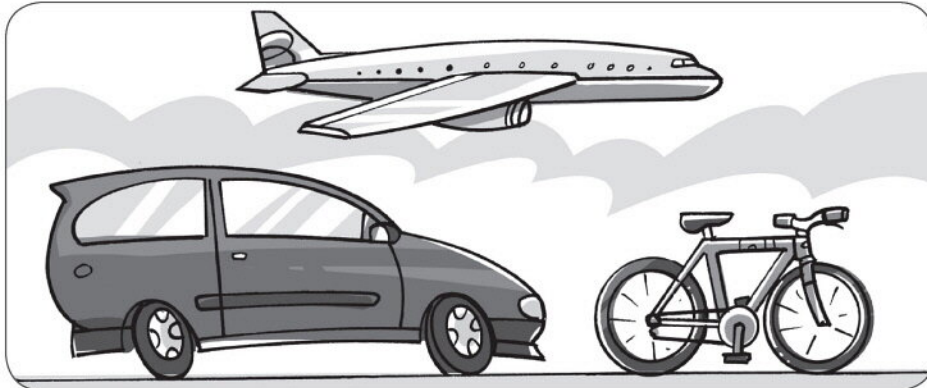

- 4 Planes are the fastest.
- 5 Bikes are faster than cars.
- 6 Cars are faster than bikes.

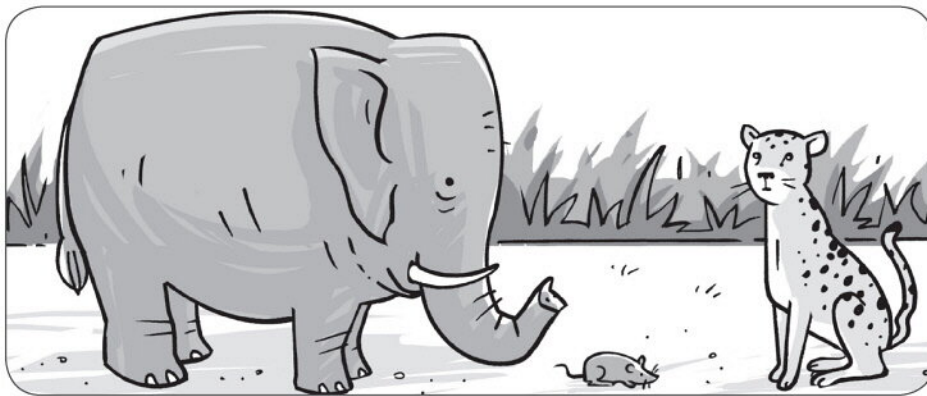

- 7 Cheetahs are the biggest.
- 8 Cheetahs are bigger than mice.
- 9 Elephants are the biggest.

2 Write.

- 1 Carl is the shortest. (short)
- 2 Ben is _____ than Adam. (short)
- 3 Bikes are the _____. (slow)
- 4 Cars are _____ than planes. (slow)
- 5 Cheetahs are _____ than elephants. (small)
- 6 Mice are the _____. (small)

3 Write the answers.

- 1 Are cheetahs faster than elephants? Yes, they are.
- 2 Are bikes bigger than cars? _____
- 3 Is Ben the tallest boy? _____

1 Look at the table. Circle the mistake in each sentence.

Write the correct sentence.  Grammar Time! page 129

—————→				
smallest	the UK	Australia	Russia	biggest
shortest	hen	horse	giraffe	tallest
slowest	car	train	plane	fastest

1 A train is faster than a plane.

A train is slower than a plane.

2 A hen is taller than a horse.

3 Australia is smaller than the UK.

4 A plane is slower than a car.

5 The UK is bigger than Russia.

6 A giraffe is shorter than a horse.

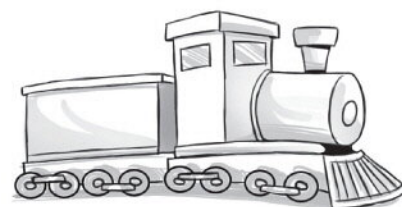
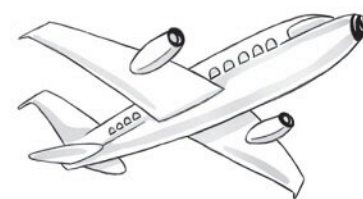

2 Tick (✓) the correct answer.

1 Which transport is faster?

a plane

a car

2 Which country is smaller?

the UK

Russia

3 What's the tallest animal?

a giraffe

a hen

a cow

4 What's the slowest transport?

a train

a plane

a car

5 What's the biggest country?

Russia

Australia

the USA











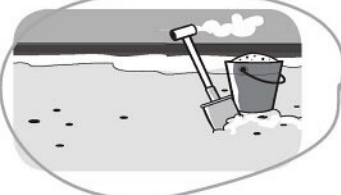

6 What's the shortest animal?

a hen

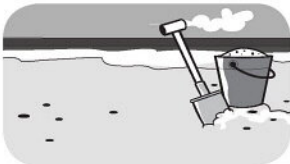
a horse

a sheep

1 Say the words with *nd*, *nt* and *mp*. Circle the odd one out. Write this word.

1				_____ sand _____
2				_____
3				_____
4				_____

2 Complete the words.



- | | |
|--|---|
| 1 There's a frog in the po <u>nd</u> . | 2 She's playing in the sa <u>nd</u> . |
| 3 I like sleeping in a te <u>nt</u> . | 4 He's holding a la <u>mp</u> . |
| 5 There's a ca <u>mp</u> in the field. | 6 There's a pla <u>nt</u> under the tree. |

3 Write.

aunt camp lamp wind pond tent plant



We put up the ¹ tent .
 At the big, big ² pond .
 We hear the ³ wind .
 We light the ⁴ lamp .
 We sit by the ⁵ pond .
 We look at the ⁶ plants .
 We're happy together,
 Just me and my ⁷ aunt .

Skills Time!

Lesson Five

Reading

1 Order the letters and write the words.



dlo
old

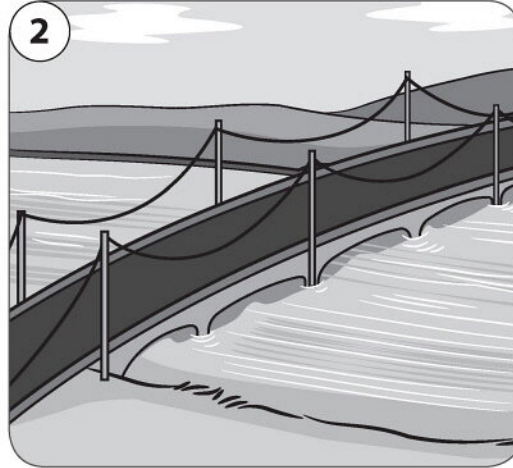

eibdr g

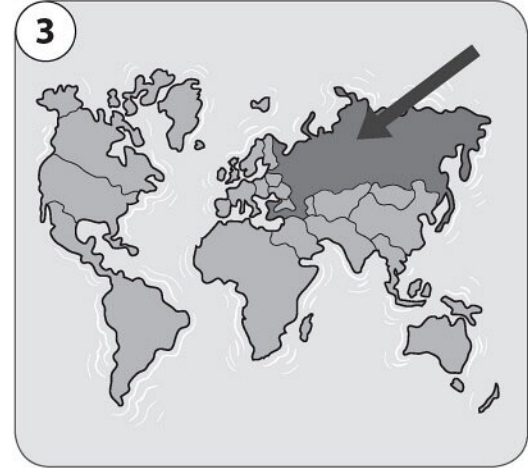

yctrnou

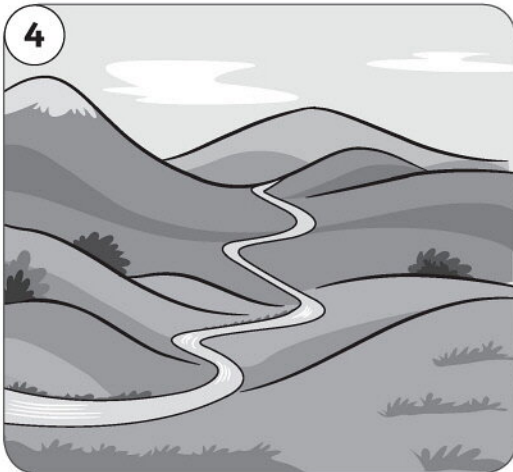

rveri

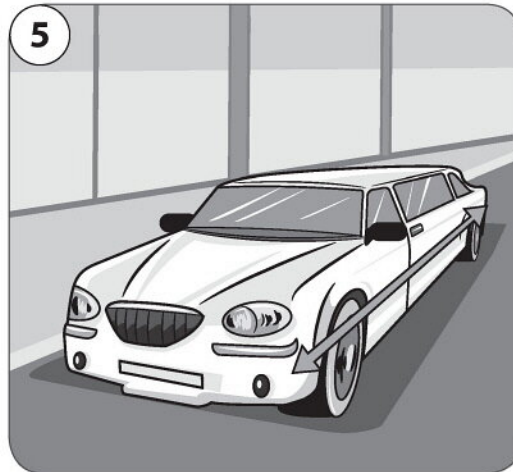

l gno

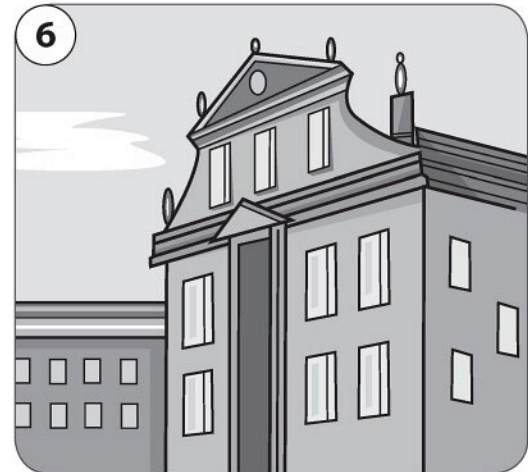

inbldigu

2 Read the text in the Class Book and write.

- 1 The Ġgantija temples are the oldest temples in Europe. They are over _____ years old.
- 2 The two bridges over Lake Pontchartrain are the _____ over water in the world. They are nearly _____ miles long.
- 3 Russia is the _____ in the world. It is about _____ square kilometres.
- 4 The Nile is the _____ in the world. It is _____ kilometres long.

Writing

1 Circle all the words you can use.

- 1 ... she watches TV in the evening.
- 2 He ... plays computer games at night.
- 3 He has a shower in the morning ...
- 4 He ... goes to the theatre on Saturdays.
- 5 ... they play football after school.
- 6 We ... go swimming at the beach.

Always / Sometimes / Never
always / sometimes / never
 always / sometimes / never
 always / sometimes / never
 Always / Sometimes / Never
 always / sometimes / never



My writing

2 Write.

make	holiday	mall	Saturdays
living	tomato	tennis	rivers

I sometimes help my dad to tidy up the ¹ living room.

I never swim in ² _____.

Sometimes I play ³ _____ with Jemma after school.

I never go to school on ⁴ _____.

I always ⁵ _____ cakes for special days.

We sometimes go on ⁶ _____ to the mountains.

I always have cheese and ⁷ _____ on pizza.

I go to the shopping ⁸ _____ with my cousin sometimes.

3 Write sentences about you. Use *always*, *sometimes* and *never*.

Fluency Time! ③

Everyday English

1 Look at the map. Write.

café library shopping mall swimming pool

1 Excuse me. Where's the library ?

It's next to the theatre.

2 Can you tell me the way to the _____ ?

Sure. Go straight on.
It's next to the playground.

3 Excuse me. Where's the _____ ?

Turn right, then go straight on.
You can't miss it.

4 Can you tell me the way to the _____ ?

Sure. Turn left. It's next to
the supermarket.

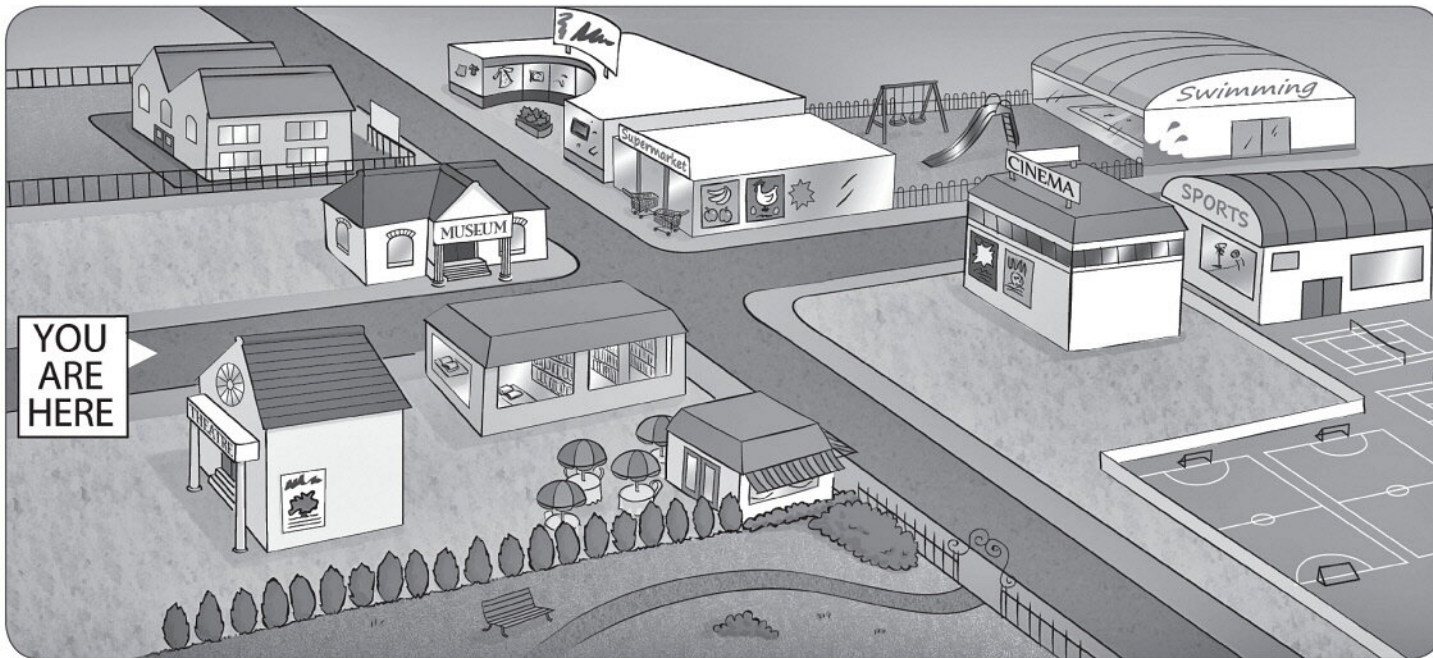

2 Look at the map again. Write.

left next to go straight on right

1 Excuse me. Where's the sports centre?

It's next to the cinema.

2 Can you tell me the way to the museum?

Sure. Turn _____.
It's opposite the supermarket.

3 Excuse me. Where's the park?

Turn _____, then
go straight on.

4 Can you tell me the way to the cinema?

Sure. _____.
You can't miss it.



1 Watch. Read the directions and write the places.

cinema museum post office

1 Turn left at the post office. _____

2 Turn right. Then go straight on. _____

3 It's next to the museum. _____

2 Read and circle. Then match.

1 Excuse me. Where's the **bank / cinema / museum?**

2 Sure. Turn left at the **cinema / post office / museum.**

3 Can you **show / tell / say** / me the way to the library, please?

4 Turn **left / right / straight**, then go straight on.



3 Think about your town. You are at the school door. Ask and answer.

Where's the ...? It's next to Go straight on Turn left Turn right

Can you tell me the way to the museum, please?

Sure. Turn right ...

1 Find and circle the words. Write the words with *a*, *an* and *some*.

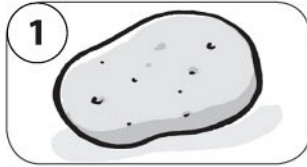

a potato

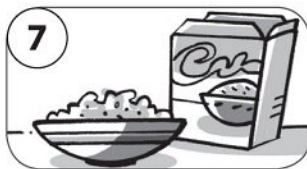

a	r	a	e	p	b	n	s	m
e	o	c	e	a	n	u	i	r
b	b	u	i	l	d	i	n	g
p	c	c	c	a	r	b	g	b
o	e	u	e	k	i	u	e	r
t	n	m	r	e	i	t	r	i
a	g	b	e	c	i	t	y	d
t	h	e	a	t	r	e	u	g
o	b	r	l	i	i	r	c	e
o	n	i	o	n	n	b	o	i

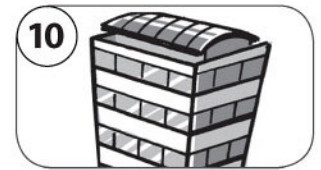
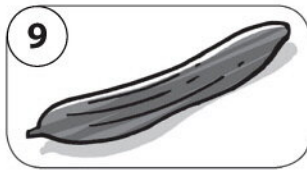

2 Write. wide big deep old long

The swimming pool in my town is 50 years ¹ old . The pool is 30 metres ² _____ and 10 metres ³ _____ . The water is 1 metre ⁴ _____ . It is quite ⁵ _____ .

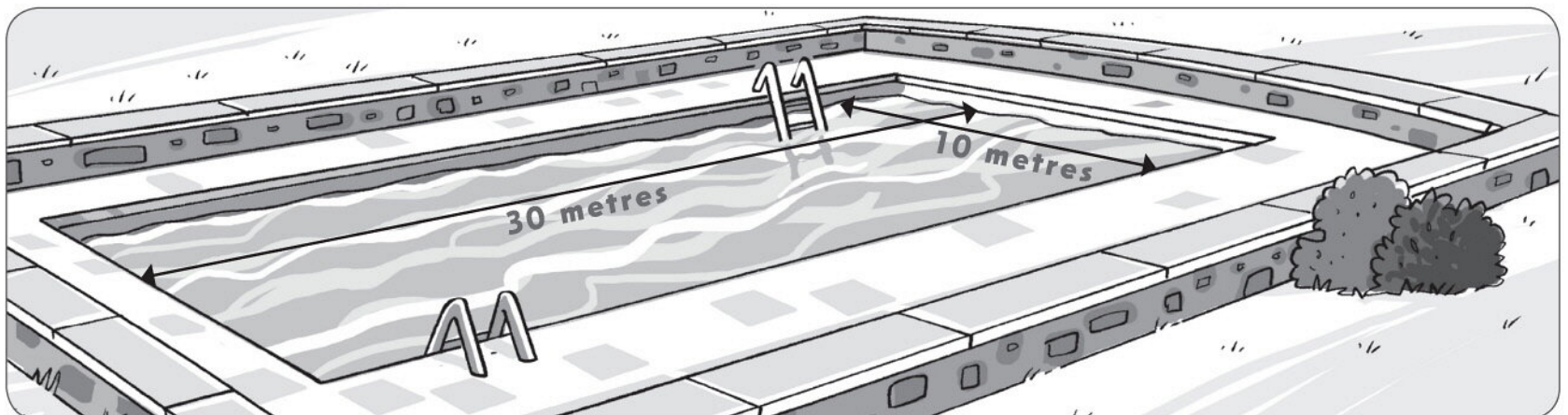

3 Complete the words. Then write the answers.

- 1 Are the pyramids old er than Big Ben? Yes, they are.
- 2 Is Brazil big _____ than Russia? _____
- 3 Is the cheetah the fast _____ animal in the world? _____
- 4 Are the Pontchartrain bridges the short _____ in the world? _____

4 Write s if you need to. Look and answer *Yes, please* or *No, thanks*.



- 1 Would you like some water ?
- 2 Would you like some peas ?
- 3 Would you like some cheese ?
- 4 Would you like some apple ?
- 5 Would you like some pasta ?

- No, thanks.
- _____
- _____
- _____
- _____

My work

My favourite story in Units 7–9 is _____
 My favourite song in Units 7–9 is _____
 My favourite unit in Units 7–9 is _____
 I need to practise _____

My work in Units 7–9 is

OK
 Good
 Excellent

Lesson One Words

1 Complete the crossword.

Down ↓

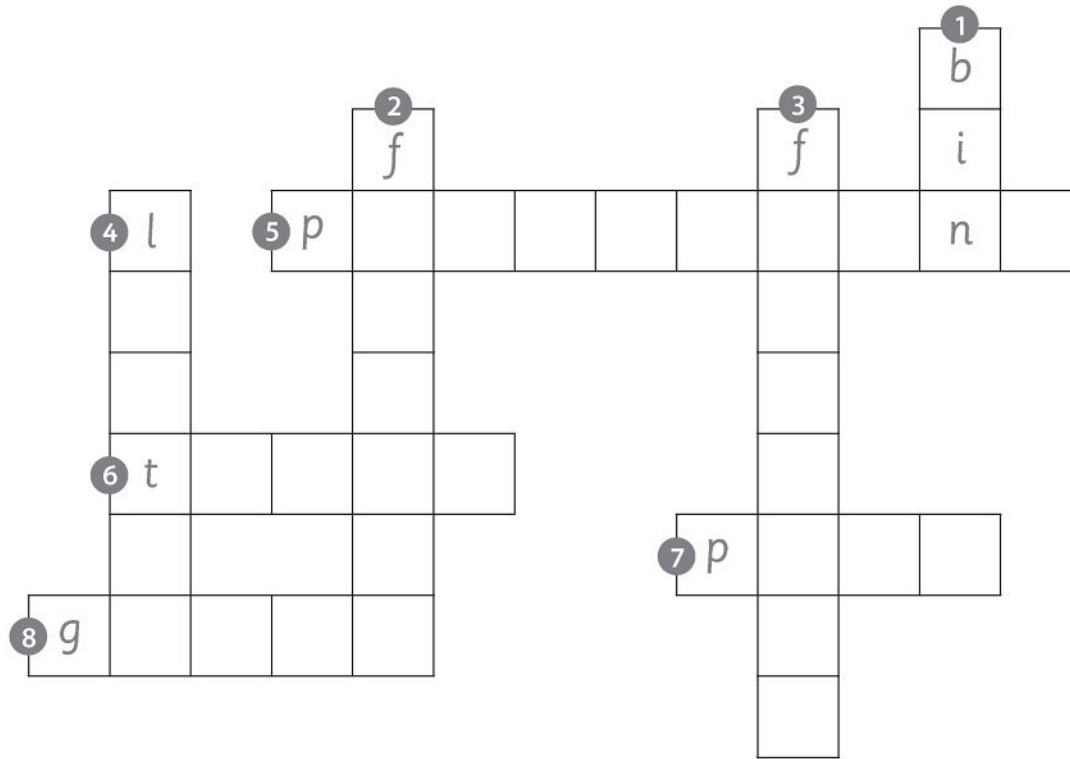
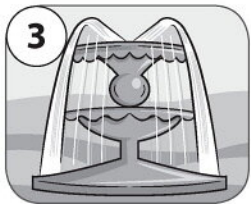

Across →

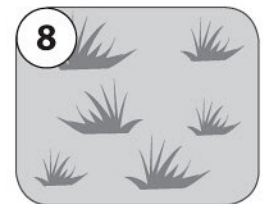
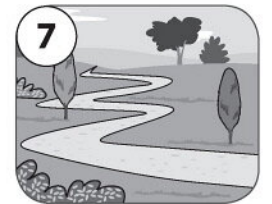
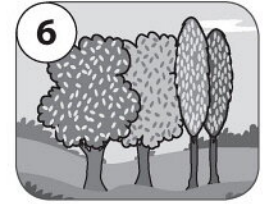

2 Write.



- 1 There's a rabbit on the grass.
- 2 There's some _____ under the slide.
- 3 There's a dog in the _____.
- 4 There are some children in the _____.
- 5 There are some _____ near the wall.
- 6 There's a cat on the _____.

1 Look at the signs. Write *must* or *mustn't*.

G Grammar Time! page 130



- 1 You mustn't play in the fountain.
- 2 You _____ walk your dog here.
- 3 You _____ put litter in the bin.
- 4 You _____ walk on the grass.
- 5 You _____ pick the flowers.

2 Complete the sentences with *must* or *mustn't*.

be do pick swim

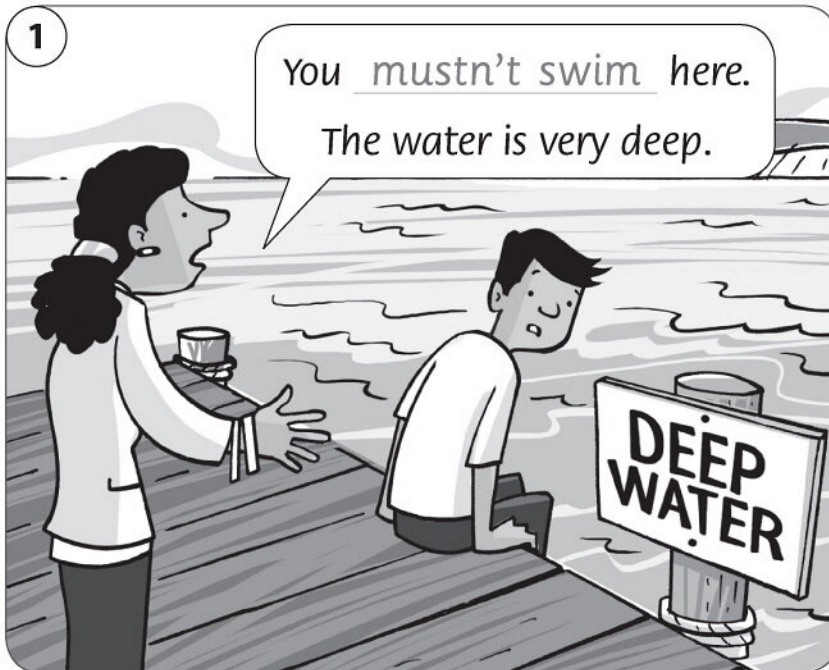

1 Look at the signs. Write sentences with *must* or *mustn't*.

G Grammar Time! page 130



1 wash / hands

You must wash your hands.

2 walk / dog

3 put / litter / bin

4 walk / grass

5 turn / off / mobile phone

2 Complete the song with *must* or *mustn't*.

You must come to the park



Oh, you ¹ must come to the park,

So we can have some fun.

You ² mustn't come to the park today,

And play games in the sun.

Oh, we ³ mustn't walk on the path,

And we ⁴ mustn't climb the trees.

We ⁵ must put litter in the bin,

Let's keep the park clean, please.

Oh, we ⁶ mustn't be very good,

And we ⁷ mustn't pick the flowers.

But we can have a lot of fun,

And play for hours and hours.

1 Complete the words with *ai*, *ay* or *a_e*.

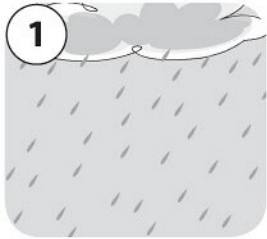

r ai n

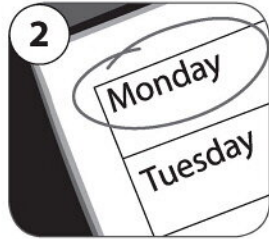

Mond ay



r ay c

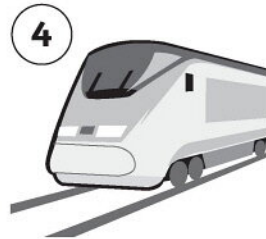

tr ay n

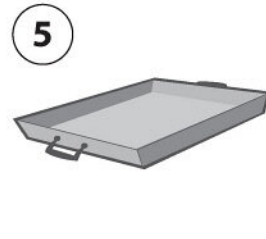

tr ay

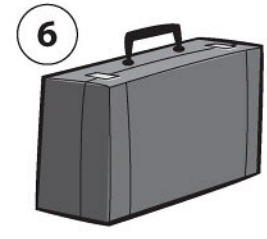

c ase

2 Write.

race train today rain case Monday play



It's ¹ Monday ² _____,
 And I can ³ _____.
 Outside there's ⁴ _____,
 But I'm in with my ⁵ _____s.
 I open my ⁶ _____,
 And the trains have a ⁷ _____!

3 Circle the correct spelling.

1

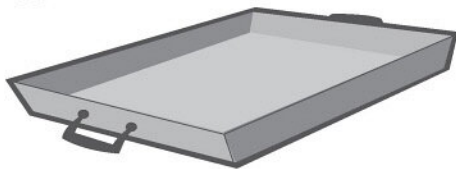

trai
tray

2



rayc
race

3

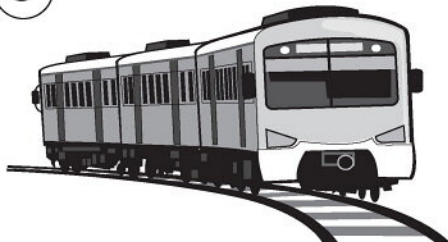

trane
train

4

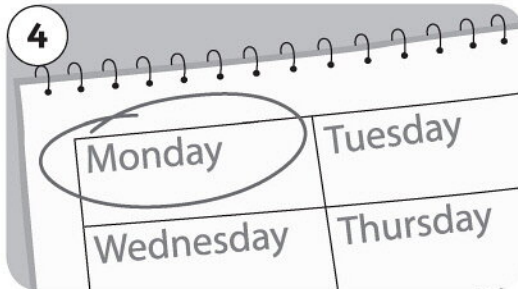

Mondai
Monday

5

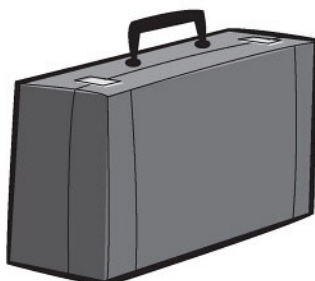

cais
case

6



rain
rayn

Skills Time!

Lesson Five

Reading

1 Look and write. Find the extra word (↓) and answer the question.

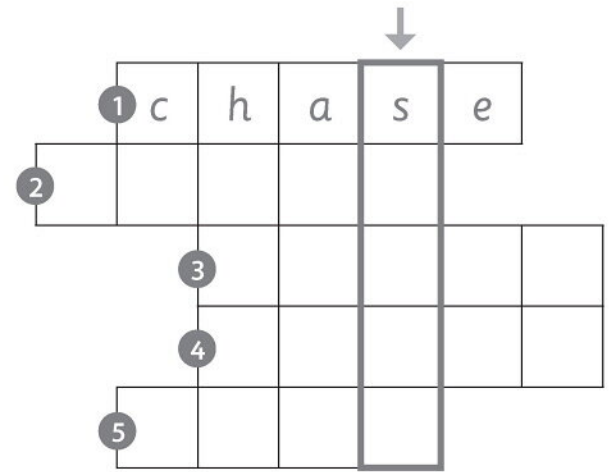

What word is the same as 'talk loudly'? _____

2 Read the text in the Class Book. Put the sentences in the correct order.

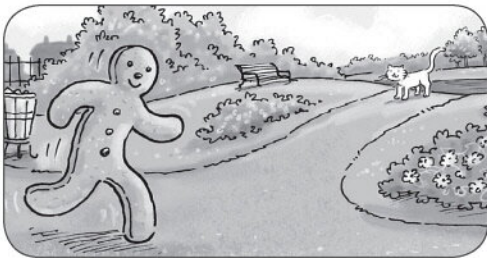

- a The old woman wants to eat the Gingerbread Man.
- b The Gingerbread Man runs away.
- c The old woman chases him.
- d An old woman makes a Gingerbread Man.

- e He wants to cross the river, but he can't swim.
- f The Gingerbread Man meets a cat.
- g The Gingerbread Man runs to the river.
- h The cat wants to eat the Gingerbread Man.

- i The Gingerbread Man sits on the fox's nose.
- j The fox opens its mouth and eats the Gingerbread Man.
- k There is a fox near the river.
- l The Gingerbread Man sits on the fox's head and the fox starts to swim.

<input type="checkbox"/>
<input type="checkbox"/>
<input type="checkbox"/>
<input checked="" type="checkbox"/>
<input type="checkbox"/>
<input type="checkbox"/>
<input type="checkbox"/>
<input type="checkbox"/>
<input type="checkbox"/>
<input type="checkbox"/>
<input type="checkbox"/>

Writing

1 Write *and* or *or*.

- 1 She doesn't like maths or English.
- 2 He plays football _____ tennis.
- 3 I don't live in a town _____ a city.
- 4 We like maths _____ science.
- 5 I like eating bread _____ jam.
- 6 They don't play basketball _____ volleyball.



My writing

2 Write. Tick (✓) the rules that are the same in your school.

~~teacher~~ comics MP3 player quiet homework

School rules

You must listen to the ¹ teacher and work hard.

You mustn't read ² _____ or eat in the classroom.

You must do your ³ _____ and turn off your mobile phone.

You mustn't listen to your ⁴ _____ or CD player.

You must be ⁵ _____ and be kind to other children.

3 Write a poster for your school rules. Use *and* and *or*.

School rules

Lesson One Words

1 Look and count. Write the numbers.

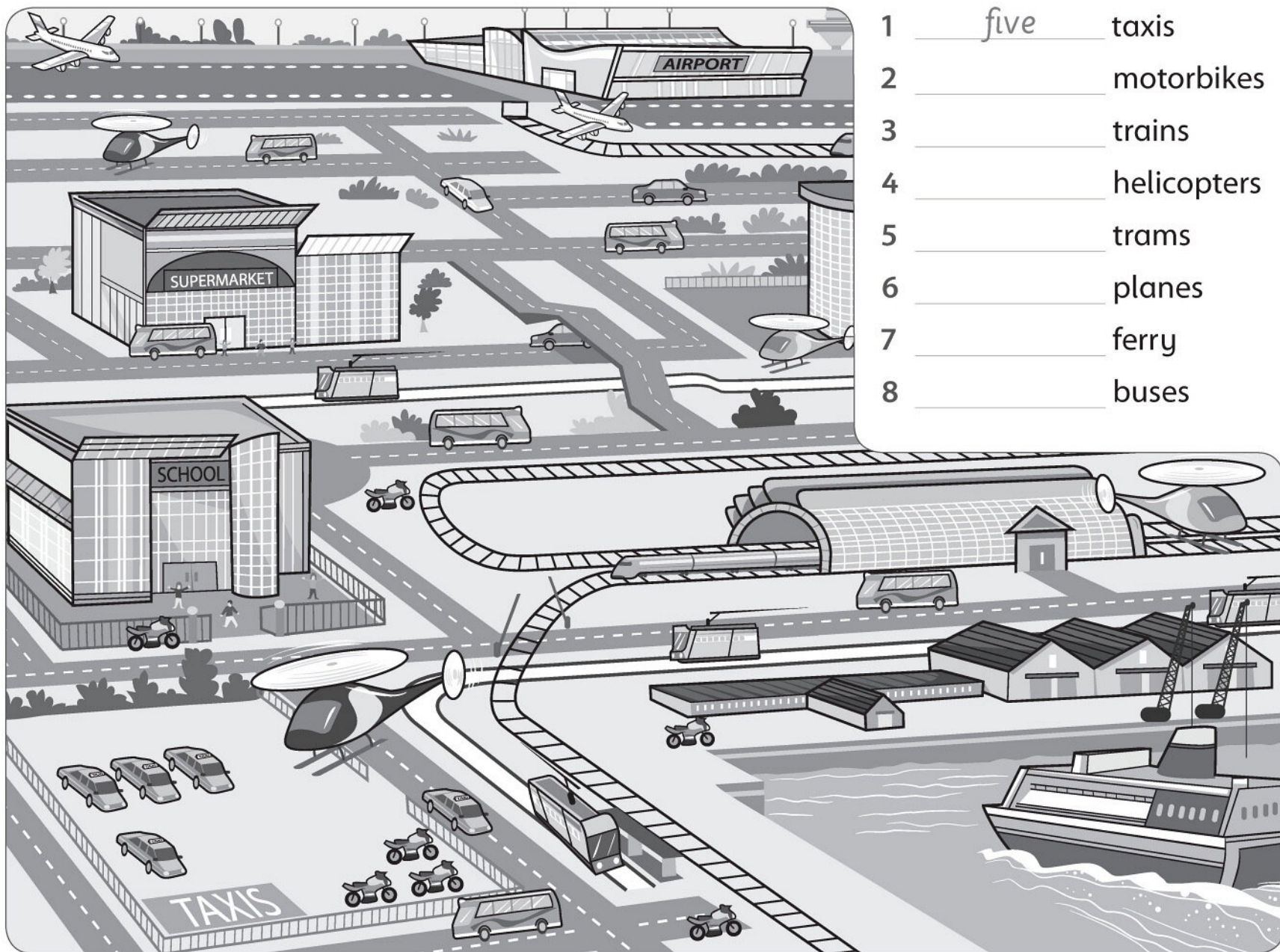

- 1 five taxis
- 2 _____ motorbikes
- 3 _____ trains
- 4 _____ helicopters
- 5 _____ trams
- 6 _____ planes
- 7 _____ ferry
- 8 _____ buses

2 Write *T* (true) or *F* (false).

- 1 There's a tram under the bridge. F
- 2 There's a train at the station. _____
- 3 There's a bus in front of the supermarket. _____
- 4 There's a ferry at the airport. _____
- 5 There's a bus on the bridge. _____
- 6 There's a taxi in front of the supermarket. _____
- 7 There's a plane at the airport. _____
- 8 There's a motorbike in front of the school. _____

1 Write *There was* or *There were*. **G** Grammar Time! page 130

- 1 There was a hotel in our town a hundred years ago.
- 2 _____ trams in our town a hundred years ago.
- 3 _____ some buses in our town a hundred years ago.
- 4 _____ a park in our town a hundred years ago.
- 5 _____ lots of bikes in our town a hundred years ago.
- 6 _____ a museum in our town a hundred years ago.

2 Write *There was*, *There were*, *There wasn't* or *There weren't*.



- 1 There weren't any books at seven o'clock.
- 2 _____ some flowers at seven o'clock.
- 3 _____ a camera at seven o'clock.
- 4 _____ a computer at seven o'clock.
- 5 _____ a banana at seven o'clock.
- 6 _____ any pens at seven o'clock.
- 7 _____ a camera at ten o'clock.
- 8 _____ some flowers at ten o'clock.

1 Circle the correct words. **G** Grammar Time! page 130



- 1 There weren't any cars **fifty years ago** / **two hundred years ago**.
- 2 There were motorbikes **fifty years ago** / **two hundred years ago**.
- 3 There weren't any bikes **fifty years ago** / **two hundred years ago**.
- 4 There weren't any buses **fifty years ago** / **two hundred years ago**.
- 5 There were taxis **fifty years ago** / **two hundred years ago**.
- 6 There were planes **fifty years ago** / **two hundred years ago**.

2 Read the song in the Class Book. Write about the town two hundred years ago.

Our town has a history

1 There weren't any buses.



2 _____ and markets.



3 _____ planes.



4 _____ and theatres.



5 _____ trains.

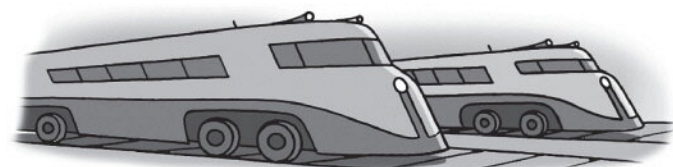

1 Look at the words with *ea*, *ee* and *y*. Circle the odd one out.

Then write these words with the correct pictures.

1 green week dream

2 lolly queen family

3 please seat happy

4 jelly tree sheep

5 family ice cream funny

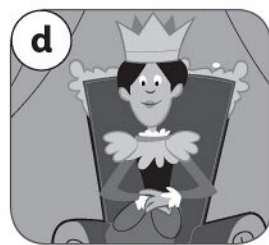
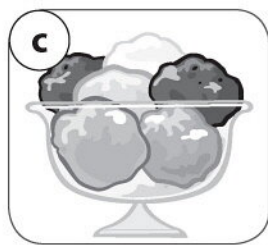
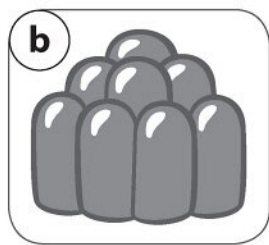
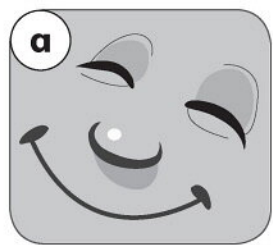

dream

2 Write.

queen happy green dream jelly ice cream



In my ¹ dream,
 I am a ² _____.
 I eat ³ _____ ⁴ _____,
 With ⁵ _____.
 I'm very ⁶ _____,
 In my dream.

3 Write.



1 My mum is sitting under a tree.

2 There are five people in my _____.

3 Can you get me a melon, _____?

4 He's eating a _____.

5 There's a _____ on the path.

Skills Time!

Lesson Five

Reading

1 Look and write.

along ~~through~~ in the middle of at the top of between inside

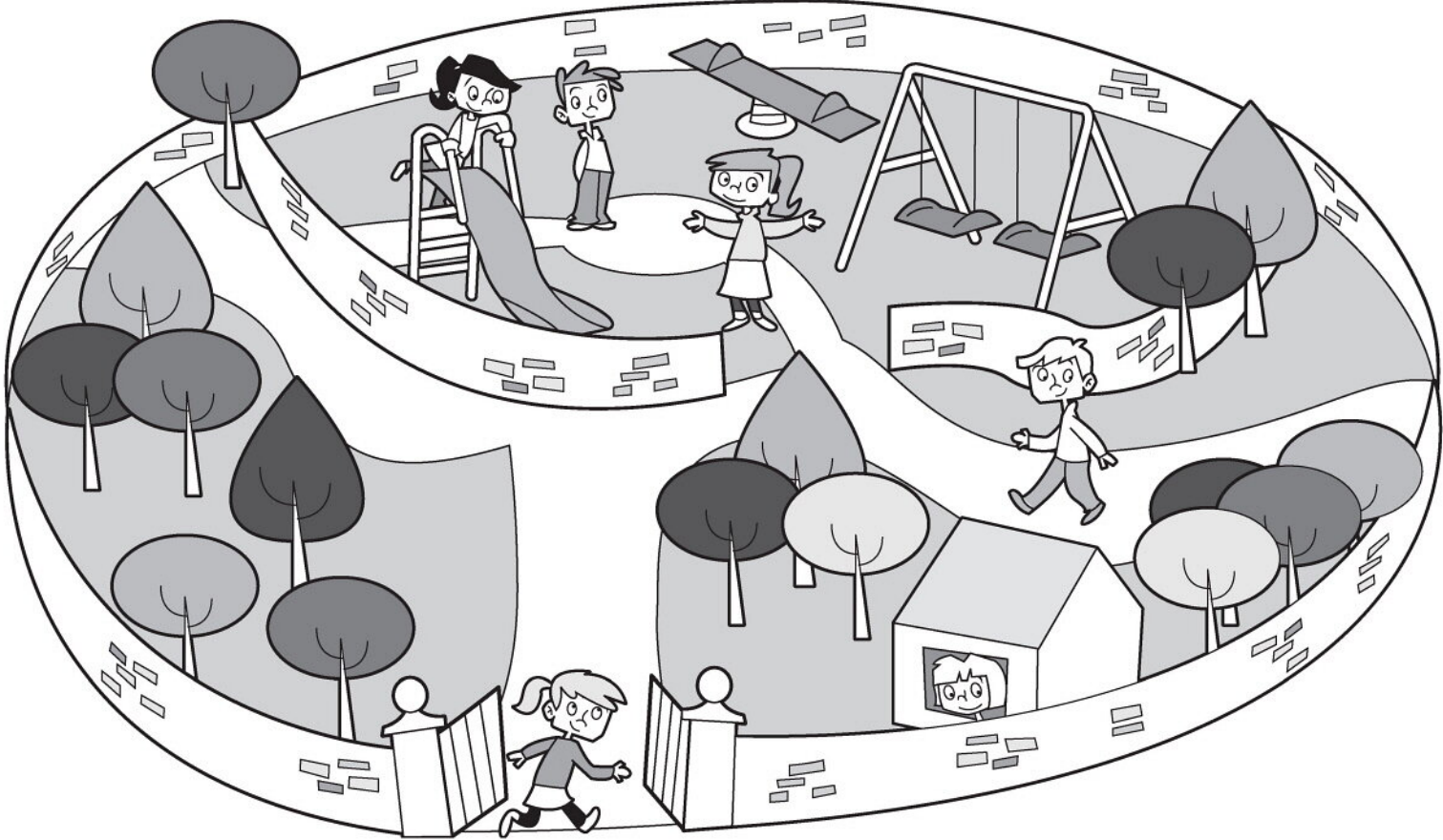

- 1 A girl is going through the gate.
- 2 A boy is walking _____ the path.
- 3 A girl is _____ the play house.
- 4 A girl is _____ the playground.
- 5 A girl is _____ the slide.
- 6 A boy is _____ the seesaw and the slide.

2 Read the Class Book. Write *T* (true) or *F* (false).

- 1 Petra is in the middle of a forest. F
- 2 Petra was a capital city. _____
- 3 The buildings in Petra were small. _____
- 4 There weren't any people in Petra for hundreds of years. _____
- 5 In 1989, Petra was in a film. _____
- 6 Petra is now famous all over the world. _____

Writing

1 Read. How many topics are there?

transport food money

Match the topics with the paragraphs.

There were fruit trees in Petra and there was a lot of fruit to eat. The city was in the desert, but it had a lot of water. There were special ways to bring water to the city.

There were shops and markets in Petra. There were coins to buy things, too. The heads of kings were on the coins.

The Nabatean people were travellers. There weren't any buses or trains, but they had camels.



My writing

2 Write. is isn't was ~~wasn't~~ are aren't were weren't

Fifty years ago, there ¹ wasn't a shopping mall in my town. There ² _____ only one café. There was a museum then. There ³ _____ any buses, but there ⁴ _____ trams.

Now, there ⁵ _____ lots of cafés. There ⁶ _____ a shopping mall, but there ⁷ _____ a museum. There are buses now, but there ⁸ _____ any trams.

3 Write two paragraphs about your town fifty years ago and now.

Fifty years ago, _____

Now, _____

Lesson One Words

1 Order the letters and write the words.

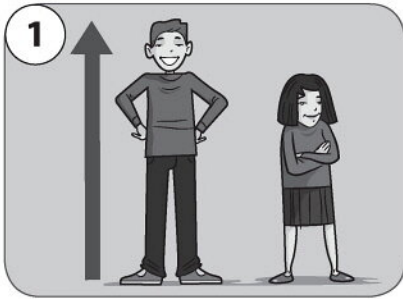

1
altl
tall



2
dol



3
hsy



4
ypttre



5
gnuyo

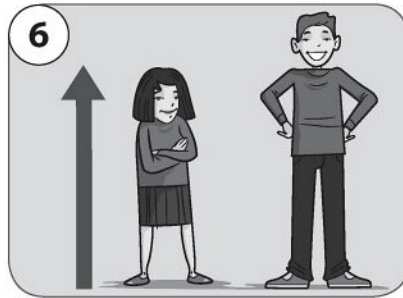

6
htsro



7
saohdnme



8
ydfiernl

2 Choose from the words above. Write.

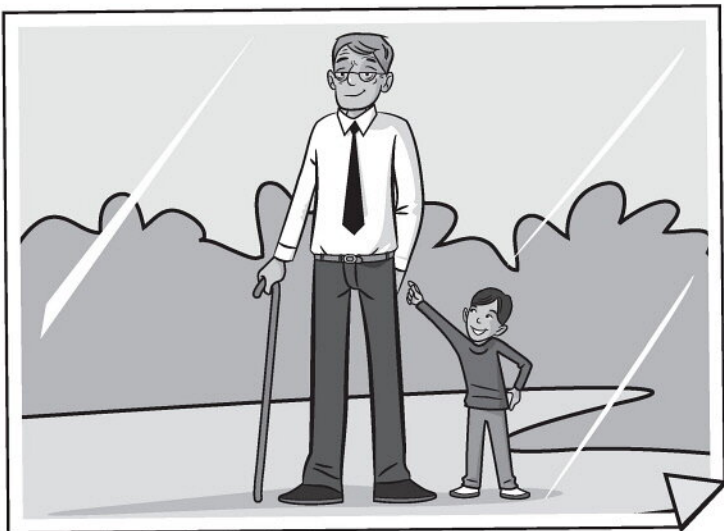

He's shy.

He's _____.

He's _____.

He's _____.



She's _____.

She's _____.

She's _____.

She's _____.

1 Read and tick (✓) the correct sentence. **G** Grammar Time! page 131



- | | | | |
|------------------------------------|-------------------------------------|---------------------------|--------------------------|
| 1 The children were at the beach. | <input type="checkbox"/> | 2 It was hot. | <input type="checkbox"/> |
| The children weren't at the beach. | <input checked="" type="checkbox"/> | It wasn't hot. | <input type="checkbox"/> |
| 3 Mum was hungry. | <input type="checkbox"/> | 4 The children were sad. | <input type="checkbox"/> |
| Mum wasn't hungry. | <input type="checkbox"/> | The children weren't sad. | <input type="checkbox"/> |
| 5 It was windy. | <input type="checkbox"/> | 6 Dad was wet. | <input type="checkbox"/> |
| It wasn't windy. | <input type="checkbox"/> | Dad wasn't wet. | <input type="checkbox"/> |

2 Complete the sentences with *He had* or *He didn't have*. **G** Grammar Time! page 132



Yesterday ...

- 1 *He didn't have* _____ breakfast in the living room.
- 2 _____ cereal for breakfast.
- 3 _____ a music lesson.
- 4 _____ sandwiches and an apple for lunch.
- 5 _____ dinner with his family.
- 6 _____ rice for dinner.

1 Look and circle the correct words.

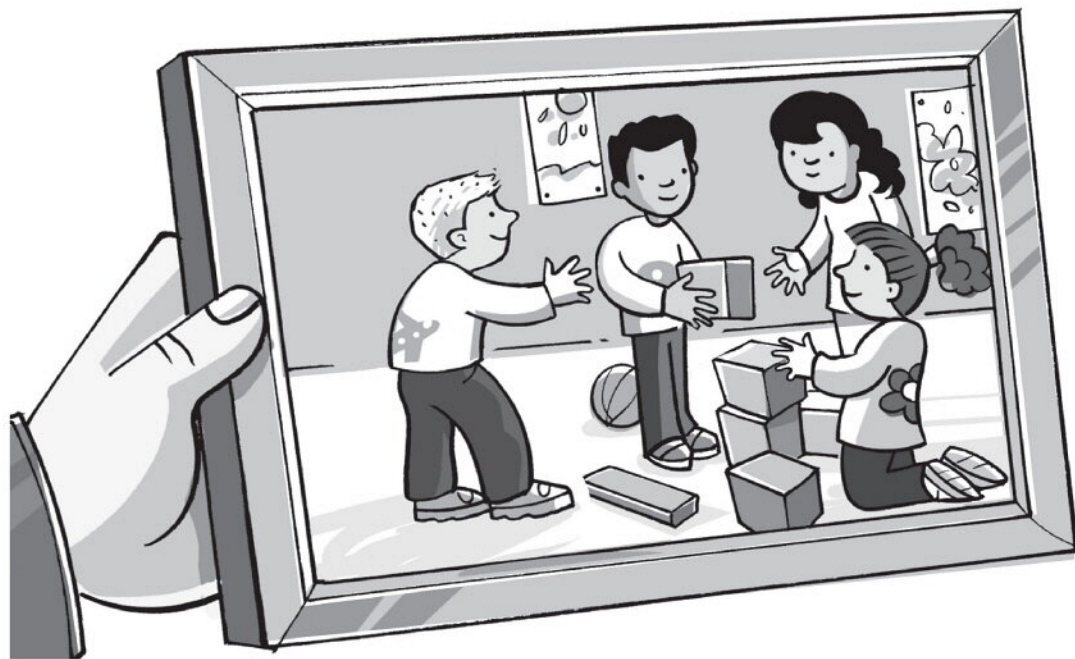

When he was two years old, ...

- 1 he was **shy** / **friendly**.
- 2 he had **long hair** / **short hair**.
- 3 he was **short** / **tall**.
- 4 he was **young** / **old**.

2 Write true sentences about you. Use *was*, *wasn't*, *had* or *didn't have*.

When I was four years old, ...

I _____ shy.

I _____ short.

I _____ long hair.

When I was six years old, ...

I _____ friendly.

I _____ short hair.

I _____ tall.

3 Complete the song with *was* or *had*.

When my grandpa was a boy



When my grandpa ¹ was a boy,
 He ² _____ a lot like me.
 He ³ _____ a house and garden,
 And a happy family.

Grandpa ⁴ _____ a happy boy,
 And he ⁵ _____ lots of friends.
 They ⁶ _____ lessons every day,
 And they ⁷ _____ fun at weekends.

When my grandpa ⁸ _____ a boy,
 He ⁹ _____ fun every day.
 He ¹⁰ _____ lots of books to read,
 And lots of games to play.

1 Say the words. Circle the word that doesn't have a long vowel sound *i*.

- | | | | | | | | |
|---------|-------|------------|-------|---------|-------|-------|-------|
| 1 sky | night | <u>six</u> | smile | 2 bin | shine | dry | light |
| 3 smile | tin | sky | dry | 4 night | fig | shine | light |
| 5 sky | night | fish | shine | 6 dry | light | smile | pink |

2 Write.

shine light ~~dry~~ smile night white sky

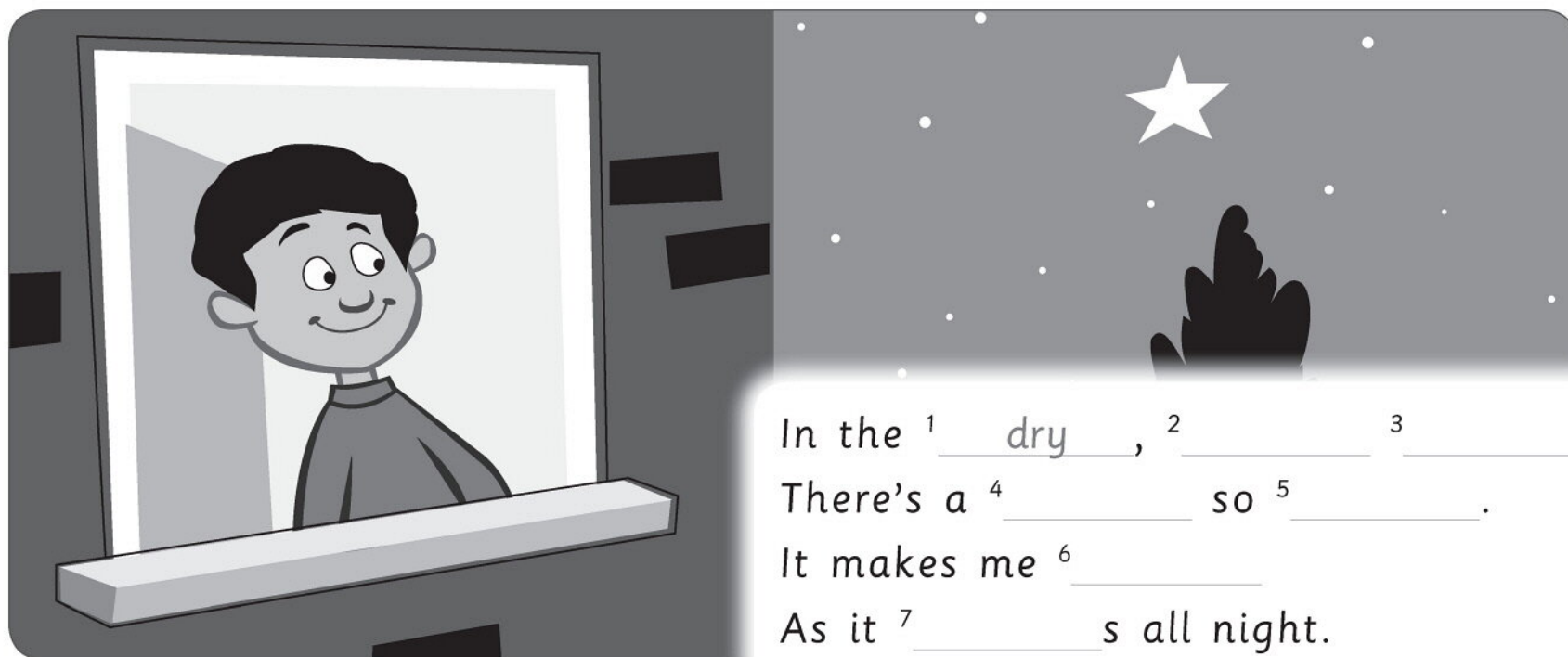

3 Write.

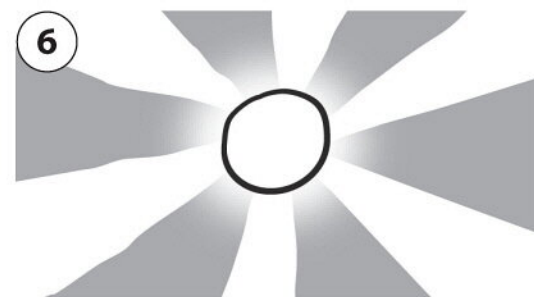
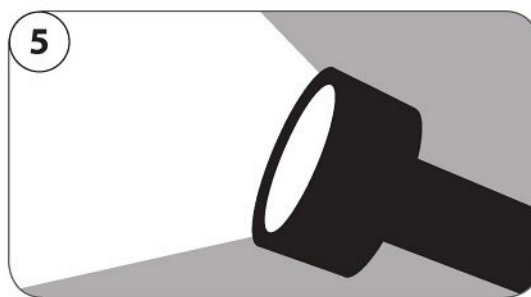
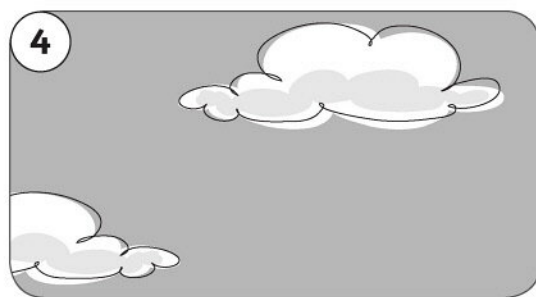
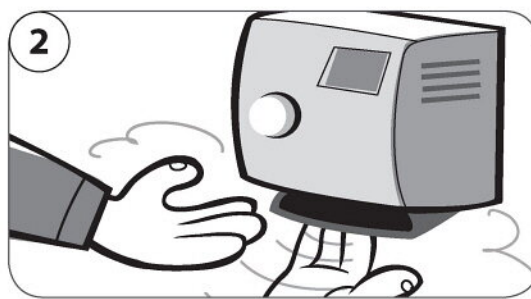
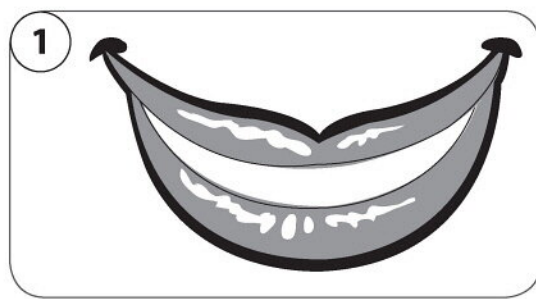

- | | |
|--|-------------------------------------|
| 1 We <u>smile</u> when we're happy. | 2 Please wash and _____ your hands. |
| 3 Some animals don't sleep at _____. | 4 There's a plane in the _____. |
| 5 We can't see when there isn't any _____. | 6 Sometimes the sun doesn't _____. |

Skills Time!

Lesson Five

Reading

1 Write.

relaxed mean miserable generous cheerful worried

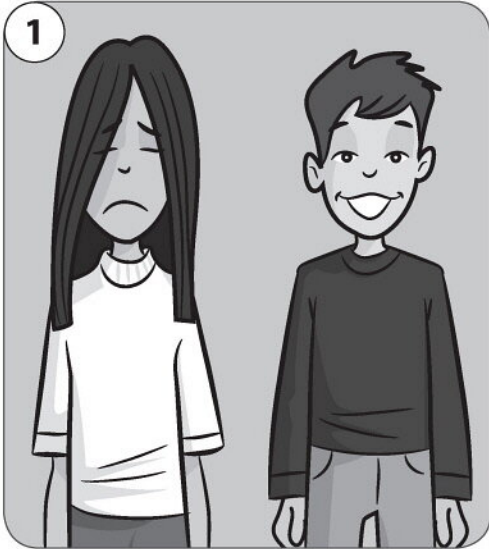

She's miserable ,
but he's _____ .



He's _____ ,
but she's _____ .

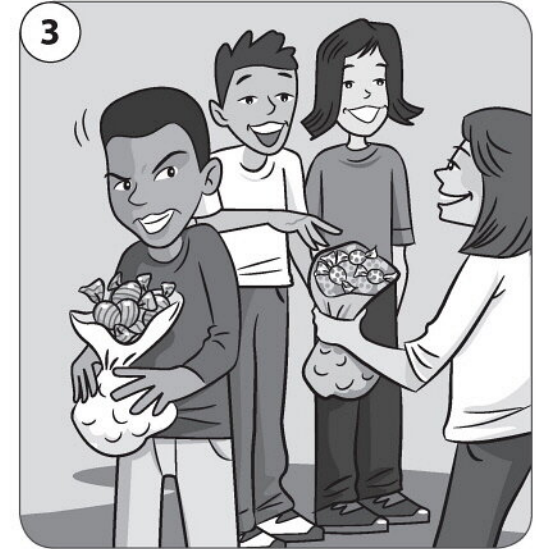

He's _____ ,
but she's _____ .

2 Read the text in the Class Book. Write *T* (true) or *F* (false).



- 1 When Grandma was ten, her eyes were green. F
- 2 When Grandma was ten, she had short, brown hair.
- 3 When Grandma was ten, she was pretty.



- 4 When Grandma was twenty-two, she had her wedding day.
- 5 When Grandma was twenty-two, she was very pretty.
- 6 When Grandma was twenty-two, she had a baby girl.



- 7 Now Grandma's hair is long and white.
- 8 Now Grandma's very miserable all the time.
- 9 Now Grandma's always nice and generous.

Writing

1 Write *and* or *but*.

- 1 My uncle is old, but he's handsome.
- 2 My aunt is generous _____ she's relaxed.
- 3 My brother is mean, _____ he's cheerful.
- 4 My mum is pretty, _____ she isn't tall.



My writing

2 Choose *and* or *but* each time.

This is a photo of my grandma and grandpa. My grandpa is 65 now ¹**and / but** he's got white hair. In the photo, he was 25 ²**and / but** he had black hair. He was friendly, ³**and / but** he wasn't handsome. My grandma is 63 now. She's got short hair. When she was 23, she had long hair. She was cheerful ⁴**and / but** pretty.

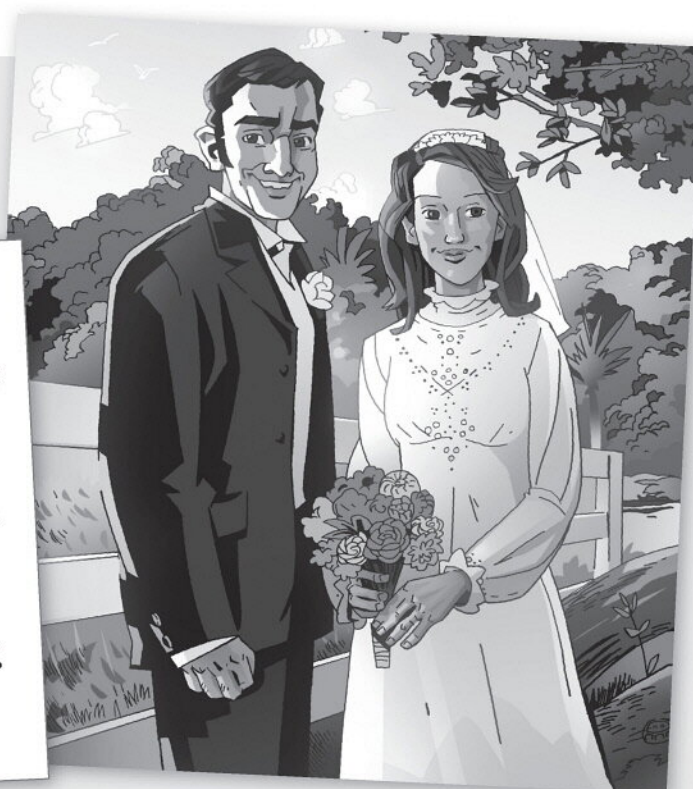

3 Find a photo of your family. Write about the people. Use *and* and *but*.

This is a photo of ... My ... is ...'s got ... In the photo, ... He / She

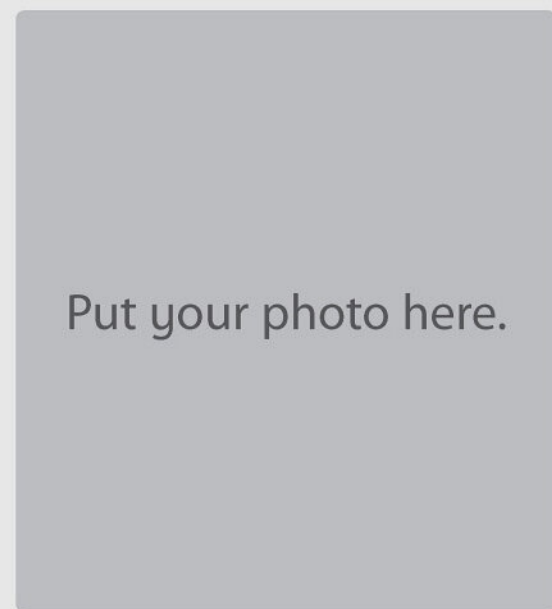

Everyday English

1 Read and tick (✓).



1

She looks cheerful.
 She looks miserable.



2

I think he's shy.
 I think he's friendly.



3

He's always generous.
 He's always mean.

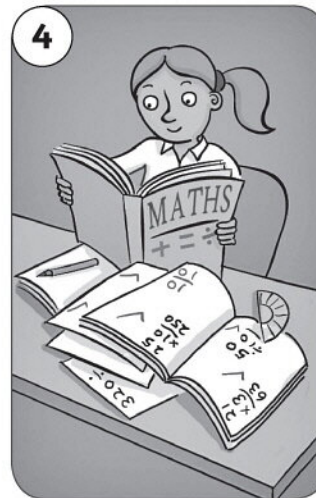

4

She looks clever.
 She looks relaxed.

2 Write.

class very do looks know
 miserable think too generous

1 Do you know Greg?

Yes, I do. He's in my class.

What's he like? He looks _____.

No, I think he is always cheerful.

Is he interesting, _____?

Yes, he is. He's very interesting.

2 Do you _____ Katya?

Yes, I do. She's in my _____.

What's she like? She _____ kind.

Yes, I _____ she is kind.

Is she _____, too?

Yes, she's _____ generous.



1 Watch. Order the words. Then match.

1 her / know / you / Do

Do you know her?

2 lives / I / in / street / know / she / that / my

3 my / class / school / in / She's / at

4 is / think / she / I / friendly



2 Watch again. Order the dialogue.

She's in my class at school.

Do you know her?

I think she is friendly.

Look! That's Sara.

What's Sara like?

I know that she lives in my street.

She always smiles and says hello.

She looks friendly.

3 Ask and answer about your friends.

What's Kim like?

I think she's generous.

1 Choose the correct word. Then write.

old sorry handsome relaxed



My grandpa was handsome.



The boy is sorry.



My dad is relaxed.

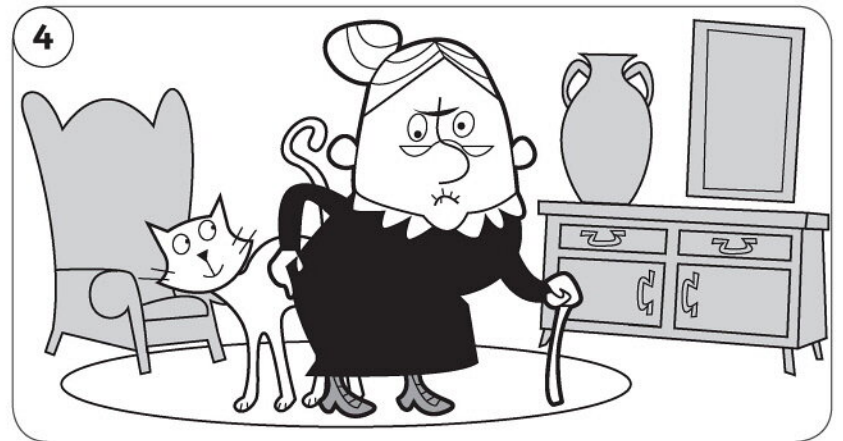

My grandma is old.

2 Join the words and make sentences.

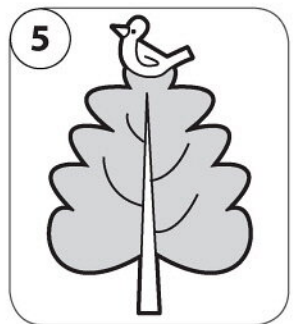
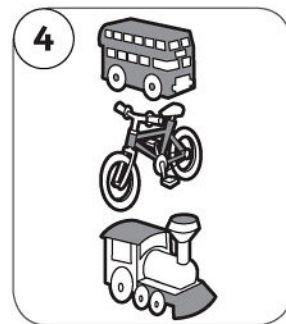
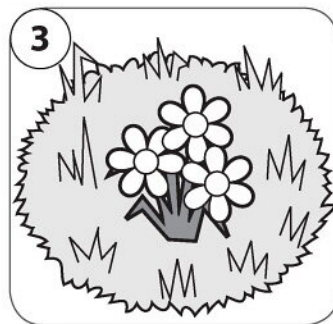
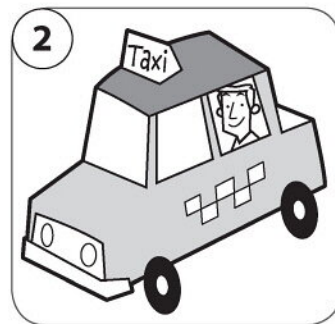
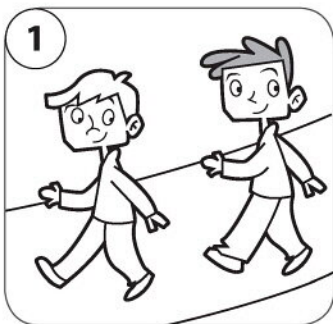

- | | | |
|------------------------|------------------|------------------------|
| 1 The boys are walking | in the middle of | the taxi. |
| 2 The man is | along | the grass. |
| 3 The flowers are | on top of | the bus and the train. |
| 4 The bike is | between | the tree. |
| 5 The bird is | inside | the path. |

3 Write *must* or *mustn't*. Tick (✓) or cross (X) the rules that are the same in your family.

- 1 You must brush your teeth every day. ✓
- 2 You _____ eat in bed. _____
- 3 You _____ shout at your mum and dad. _____
- 4 You _____ help your mum and dad. _____
- 5 You _____ play football in the house. _____
- 6 You _____ be very good. _____

4 Write *T* (true) or *F* (false).



- 1 There was a bridge. F
- 2 There were flowers. _____
- 3 There were swings. _____
- 4 There was a river. _____
- 5 There were bins. _____
- 6 There was a café. _____

5 Write *There was*, *There were*, *There wasn't* or *There weren't*.

- 1 There wasn't a bridge.
- 2 _____ a fountain.
- 3 _____ trees.
- 4 _____ a playground.
- 5 _____ birds.
- 6 _____ paths.

My work

My favourite story in Units 10–12 is _____

My favourite song in Units 10–12 is _____

My favourite unit in Units 10–12 is _____

I need to practise _____

My work in Units 10–12 is



OK



Good



Excellent

Lesson One Words

1 Find and circle the verbs. Then write.



use

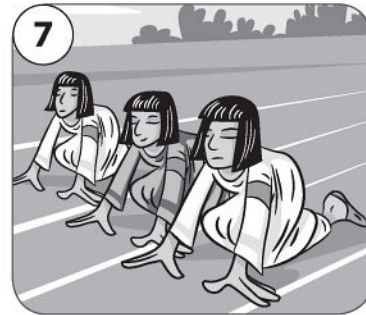
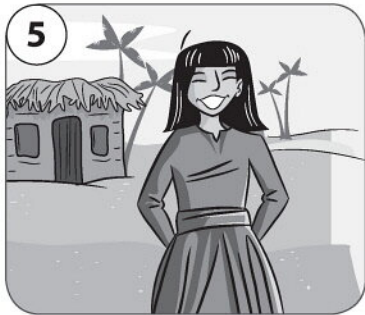

o	p	q	x	w	d	m	n
w	h	e	y	a	f	a	d
u	a	w	v	n	i	l	m
s	t	a	r	t	n	o	k
e	e	b	i	l	i	v	e
c	b	j	m	k	s	e	p
x	t	z	b	a	h	f	t
o	l	a	u	g	h	u	r



2 Write. Choose from the words above.

- They start school at half past eight in the morning.
- They _____ a computer to write emails.
- They _____ in an old house.
- They _____ kayaking. It's their favourite sport.
- They _____ school at three o'clock in the afternoon.
- They _____ getting up early in winter. It's very cold.
- They _____ something to eat. They're hungry.
- They _____ when they read a funny story.



1 Circle the correct words.

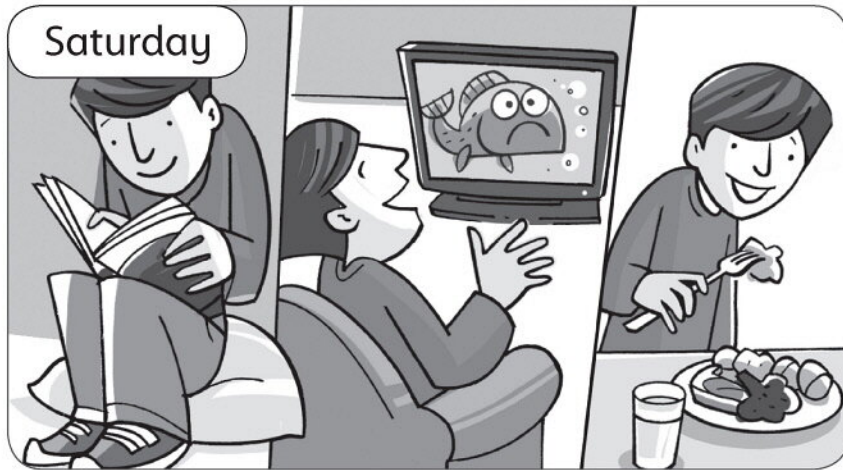

- 1 He hated his dinner on **Saturday** / **Sunday**.
- 2 He finished his homework on **Saturday** / **Sunday**.
- 3 He started reading a book on **Saturday** / **Sunday**.
- 4 He used the computer on **Saturday** / **Sunday**.
- 5 He loved his dinner on **Saturday** / **Sunday**.
- 6 He laughed at a TV programme on **Saturday** / **Sunday**.

2 Complete the sentences. **G** Grammar Time! page 132



They worked (work) in the garden yesterday.
 They didn't play (play) computer games.



He _____ (listen) to music yesterday.
 He _____ (watch) TV.



She _____ (watch) a play yesterday.
 She _____ (cook) a fish pie.



They _____ (play) basketball yesterday.
 They _____ (watch) a puppet show.

1 Write in the past simple. Then tick (✓) the sentences that are true for you.

G Grammar Time! page 132

play listen play watch play watch

- 1 I played football at the weekend.
- 2 I _____ TV at the weekend.
- 3 I _____ computer games at the weekend.
- 4 I _____ to music at the weekend.
- 5 I _____ the guitar at the weekend.
- 6 I _____ a DVD at the weekend.

2 Write things you did and didn't do at the weekend.

- 1 I _____ at the weekend.
- 2 I _____ at the weekend.
- 3 I didn't _____ at the weekend.
- 4 I didn't _____ at the weekend.







3 Read the song in the Class Book. Complete the table.

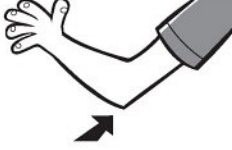

Things I did on my birthday	Things I didn't do on my birthday
I opened <u>lots of birthday cards.</u>	I didn't _____
I started _____	I didn't _____
Lots of _____	_____
We _____	_____
I _____	_____
We _____	_____

1 Say the words with *ow*, *oa* and *o_e*. Circle the odd one out. Write this word.

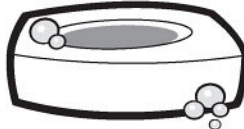
nose soap snow elbow





1				soap
2				_____
3				_____
4				_____

2 Write. nose coat elbow snow

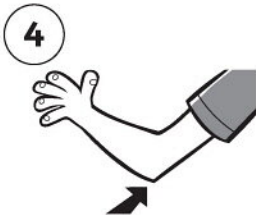

I put on my ¹ coat
 And go out in the ² _____.
 There is snow on my ³ _____
 And on my ⁴ _____.

3 Write.

1	2	3	4	5	6
					

- 1 I wash my hands with soap and water.
- 2 In winter, I put on my warm _____.
- 3 I've got brown eyes and a small _____.
- 4 My _____ is on my arm.
- 5 A _____ is hard.
- 6 There is a lot of _____ in Russia in winter.

Skills Time!

Lesson Five

Reading

1 Circle the correct words.



- 1 Clay tablets were very **heavy** / **light**.
- 2 They were very **hard** / **soft** when they were dry.
- 3 Clay tablets were **difficult** / **easy** to break.

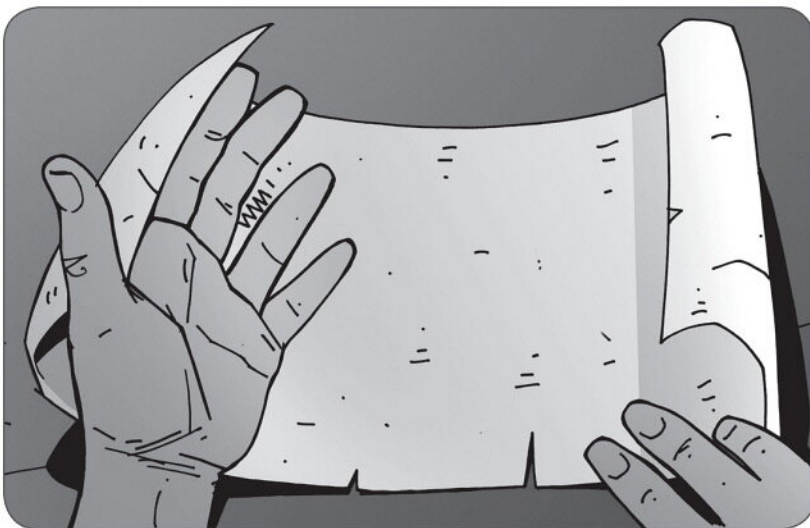

- 4 Papyrus was very **light** / **heavy**.
- 5 It was also **hard** / **soft**.
- 6 Papyrus was **easy** / **difficult** to make.

2 Read the Class Book. Write *T* (true) or *F* (false).

- 1 Five thousand years ago, people wrote on paper. F
- 2 People used a reed to write on wet clay.
- 3 Clay tablets were very heavy.
- 4 They were difficult to break.
- 5 People used each tablet many times.
- 6 Papyrus is a kind of plant.
- 7 Papyrus was soft and light.
- 8 People in other countries also started to use papyrus.
- 9 Papyrus was not expensive.
- 10 Sometimes people washed papyrus and used it again.

Writing

1 Draw * at the start of each new paragraph.

* The Ancient Egyptians had brown eyes and black hair. Men and women had long hair. They were not very tall, but they were healthy. There weren't any roads in Ancient Egypt. People walked or travelled by boat on the River Nile. People used donkeys to carry things on land. The Ancient Egyptians didn't have shops and they didn't use money. There was a market in town. They exchanged food and drink and other things.



My writing

2 Write. playing write helped balls had school

Ancient Egyptian children loved ¹ playing with wooden animals.

They ² _____ dolls and they also played with ³ _____.

Only boys from rich families studied at ⁴ _____. They learned to read and

⁵ _____. They studied maths and languages, too. Girls stayed at home and

⁶ _____ their mothers.

3 Write two paragraphs about children today.

Lesson One Words

1 Write.



apron

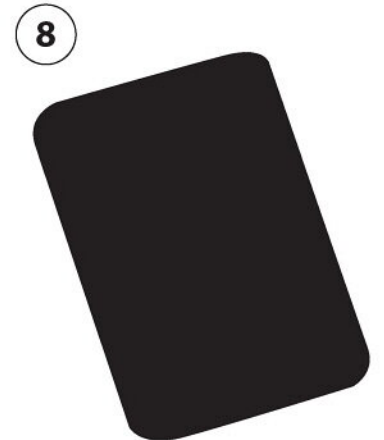
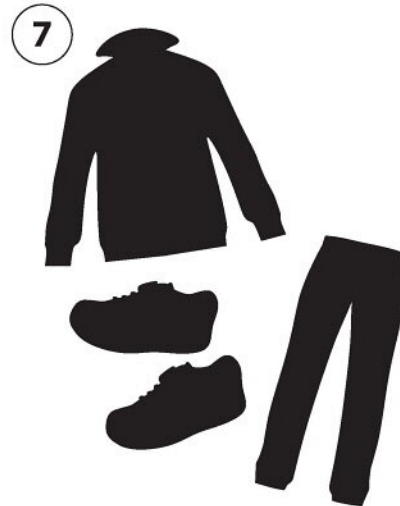
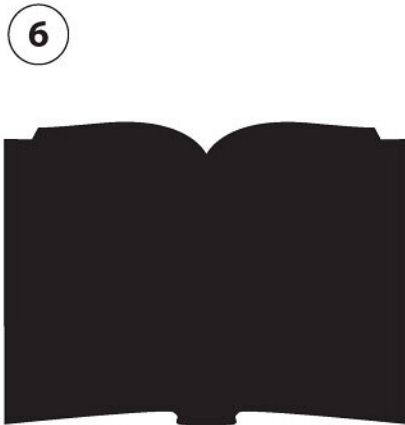
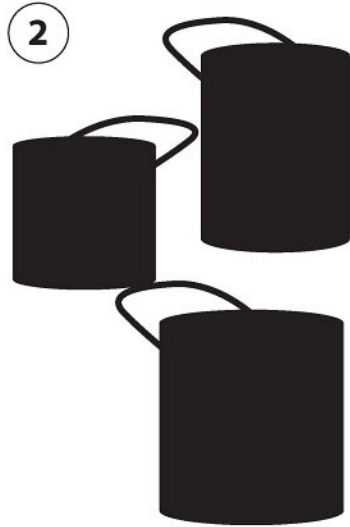

2 Choose from the words above. Write.

- 1 I always use a paintbrush in art.
- 2 I always wear my _____ in art.
- 3 I sometimes use purple _____ in art.
- 4 I always put my lunch in my _____.
- 5 I sometimes use a _____ in maths.
- 6 I always wear my _____ in PE.
- 7 I always put my school things in my _____.
- 8 I sometimes use a _____ in English.

1 Circle the correct answer. **G** Grammar Time! page 133

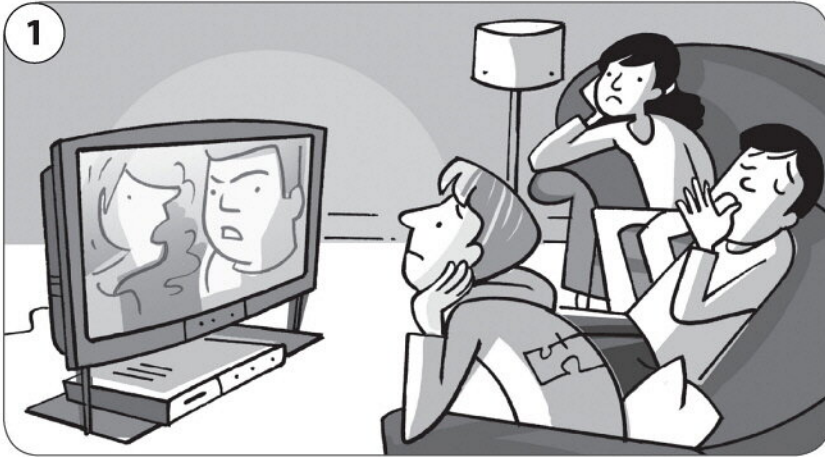

Did they like the film?
Yes, they did. / No, they didn't.



Did he have lunch at school?
Yes, he did. / No, he didn't.



Did she use her dictionary in the English lesson?
Yes, she did. / No, she didn't.



Did they have art today?
Yes, they did. / No, they didn't.

2 Complete the sentences with *What*, *When* or *Where* and *did*.

1 What did your dad watch on TV?

A film.

2 you have breakfast?

At eight o'clock.

3 you play football?

At the sports centre.

4 your mum cook for dinner?

A fish pie.

5 you visit your grandpa?

On Saturday.

6 you have dinner?

In a restaurant.

1 Look and write. Then answer *Yes, I did* or *No, I didn't*.

G Grammar Time! page 133

1 Did you use a paintbrush at school yesterday?
 ✓ Yes, I did.



2 Did you use _____ at school yesterday?
 X _____

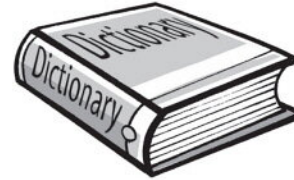

3 Did you use _____ at school yesterday?
 ✓ _____



4 Did you use _____ at school yesterday?
 X _____



5 Did you use _____ at school yesterday?
 X _____



2 Write. Then answer for you with *Yes, we did* or *No, we didn't*.

have have help like paint play

Did you have a good day?



- 1 Did you have _____ a good day at school today? Yes, we did.
- 2 _____ a picture at school today? _____
- 3 _____ a new game at school today? _____
- 4 _____ lots of fun at school today? _____
- 5 _____ your lessons at school today? _____
- 6 _____ your teacher at school today? _____

1 Match.

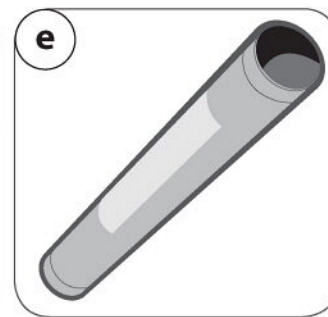

- 1 boot 2 moon 3 tube 4 glue 5 tune

2 Write.

June blue tube moon tune school flute glue



It's Tuesday night,
 And I'm not at ¹ school .
 I've got ² _____ and ³ _____ s,
 And paint that's ⁴ _____ .
 I make a toy ⁵ _____ ,
 I look up at the ⁶ _____ .
 It's a hot ⁷ _____ night,
 And I play a ⁸ _____ .

3 Read and number the pictures. Then write.

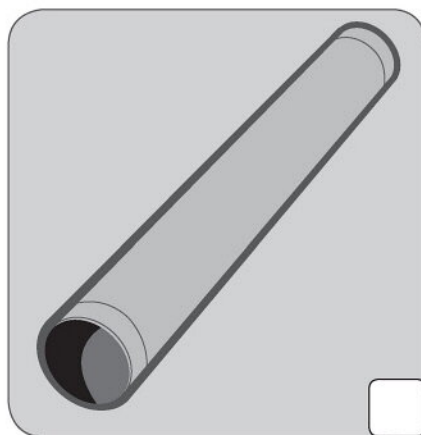

- 1 At night, you can see the moon in the sky.
 2 My brother can play a _____ on the flute.
 3 A _____ is long and round.
 4 You can make a cube with paper and _____ .

Reading

1 Write.



- 1 The rope _____ holds the tent up.
- 2 The t _____ stops us from getting wet when it rains.
- 3 We can see at night with a t _____.
- 4 We have to light a fire with m _____.
- 5 My s _____ is warm at night.
- 6 We cook food with a f _____.

2 Read the text in the Class Book. Circle the wrong words. Write the correct words.

- 1 The campsite was near the sea. _____ a river
- 2 The children used rope and wood to make a tent. _____
- 3 They used matches to see in the dark. _____
- 4 There was a sheep next to their tent. _____
- 5 It rained every day. _____
- 6 The children used a stone to start a fire. _____

Writing

1 Circle the correct words.

Last Wednesday, we were on a school trip. We visited a museum in the morning.

¹ **First** / Then, we watched a DVD. ² **Finally** / Then, we looked at photos. ³ **First** / Next, we played with old clothes and toys. ⁴ **Finally** / Then, we had lunch in the café.



My writing

2 Put the sentences in the correct order.

What did you do at school today?

a Next, we had a music lesson. We played the guitars together – it was great!

b Finally, we played football in the playground, and I walked home with my mum.

c First, I talked to my friends in the playground.

d Then, we had maths with Mr Taylor.

3 Write about your school day. Use time words.

First Then Next Finally

Lesson One Words

1 Look and write. Find the extra word (↓) and answer the question.

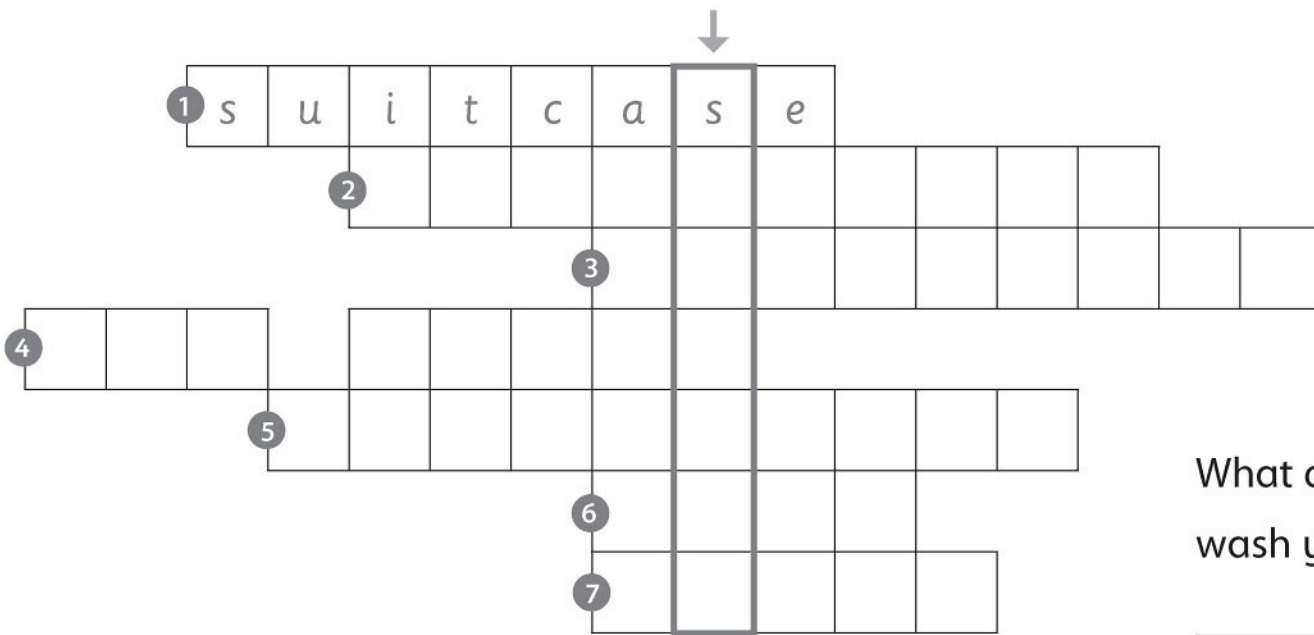
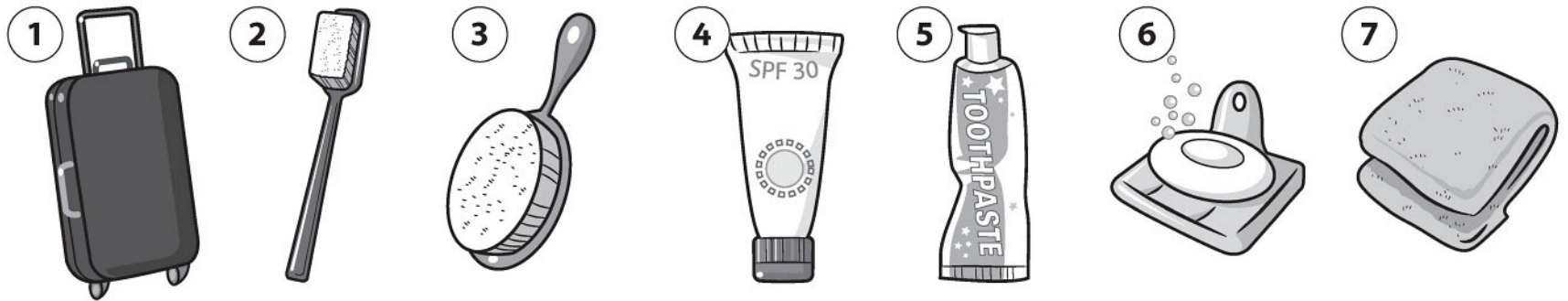

What do you use to wash your hair?

2 Write.



- 1 The sun cream is in the suitcase.
- 2 The towel is next to the _____.
- 3 The _____ is next to the shampoo.
- 4 The _____ is under the soap.
- 5 The _____ is in front of the toothbrush.
- 6 The _____ is on top of the towel.
- 7 The _____ is behind the toothpaste.
- 8 The hairbrush is between the toothbrush and the _____.

1 Write. **G** Grammar Time! page 134

- 1 Is he going to visit his cousins next week?
- 2 Are they going to swim in the sea?
- 3 Is it going to rain tomorrow?
- 4 Are you going to take your shampoo on holiday?
- 5 Is she going to buy sun cream later?
- 6 Are you going to play tennis on Tuesday?

Yes, he is .
 No, _____ .
 No, _____ .
 Yes, _____ .
 Yes, _____ .
 No, _____ .

2 Complete the sentences with *going to*.

buy have listen make play read



Lesson Three Grammar and Song

1 Look at the Class Book. Match. G Grammar Time! page 134

- 1 Is Alex going to take a towel?
- 2 Is Emma going to take a toothbrush?
- 3 Are Emma and Billy going to take some sun cream?
- 4 Are Alex and Tom going to take some toothpaste?
- 5 Is Tom going to take some soap?
- 6 Is Billy going to take a hairbrush?

C

- a Yes, they are.
- b No, he isn't.
- c Yes, he is.
- d No, she isn't.
- e Yes, he is.
- f No, they aren't.

2 Write sentences with *is*, *isn't*, *are* or *aren't*.



Alex is going to take
some shampoo.



Emma and Billy _____
_____.



Billy _____
_____.



Alex _____
_____.

3 Write. time photos going some to suitcase go take

I'm going to pack my ¹ suitcase,
I'm going to ² _____ away.
I'm going to have a great ³ _____,
I'm going on holiday!
I'm going to ⁴ _____ some sun cream,
And also some shampoo.
I'm ⁵ _____ to take my toothbrush,
And ⁶ _____ toothpaste, too.
I'm going to take some ⁷ _____,
I'm going to see the sea.
I'm going ⁸ _____ swim and windsurf,
I'm going to waterski!

I'm going to pack my suitcase



1 Complete the words.

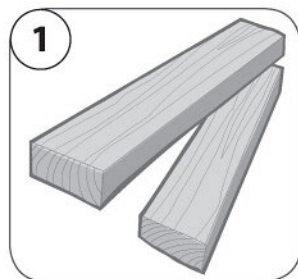

1
wood



2
oo



3
oo



4
oo

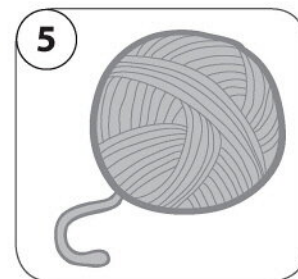

5
oo

2 Write.

good cook hood book wool wood



It's a very cold day.
I've got a coat with a ¹ hood .
I've got my ² scarf,
And I'm feeling ³ .
I'm sitting on some ⁴ .
I'm looking at my ⁵ .
The book's very good.
It tells me how to ⁶ .

3 Read and number the pictures. Then write.

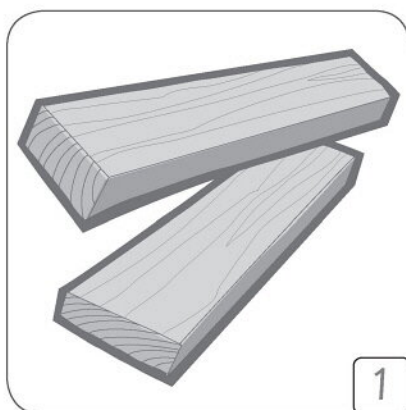

1

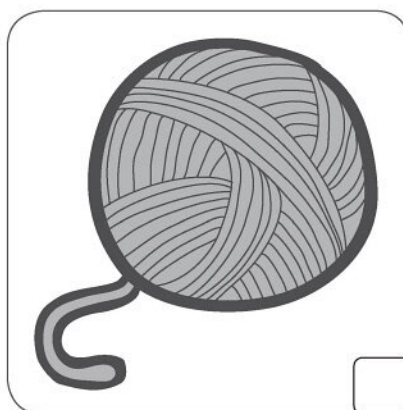

- 1 You can use rope and wood to make a bridge.
- 2 A _____ works in a kitchen.
- 3 I haven't got a hat, but my jacket's got a _____.
- 4 I've got a ball of _____ and I want to make a scarf.

Lesson Five

Reading

1 Read the text in the Class Book and write.

tonight ~~this afternoon~~ soon tomorrow later next week

1 William and his family are going to visit the aquarium this afternoon.

2 They are going to see a dolphin show _____.

3 William is going to try seafood _____.

4 William is going to swim in the sea _____.

5 William and his family are going to fly home _____.

6 William and Dan are going to look at lots of photos _____.



2 Write short answers.

1 Is Dan in Barcelona?

No, he isn't.

2 Is William having fun?

3 Does William's sister like sharks?

4 Is there a dolphin show at the aquarium?

5 Are there penguins at the aquarium?

6 Is William going to take photos?

3 Circle the mistakes. Write the correct words.

1 The weather is cold and sunny.

hot

2 The amusement park is boring.

3 William and his family are going to visit the zoo this evening.

4 William's sister loves sharks.

5 William and his family are going to visit a museum tomorrow.

6 They are going to drive home next week.

Writing

1 Where do we use these words in a letter? Circle *start* or *end*.

- | | | | |
|---------------------------|--------------------|-----------------|-------------|
| 1 Write soon. | start / <u>end</u> | 2 See you soon. | start / end |
| 3 How are you? | start / end | 4 Dear ... | start / end |
| 5 Thanks for your letter. | start / end | 6 Bye for now. | start / end |



My writing

2 Read the email. Underline the start words in red and the end words in blue. Order the pictures and write the numbers.

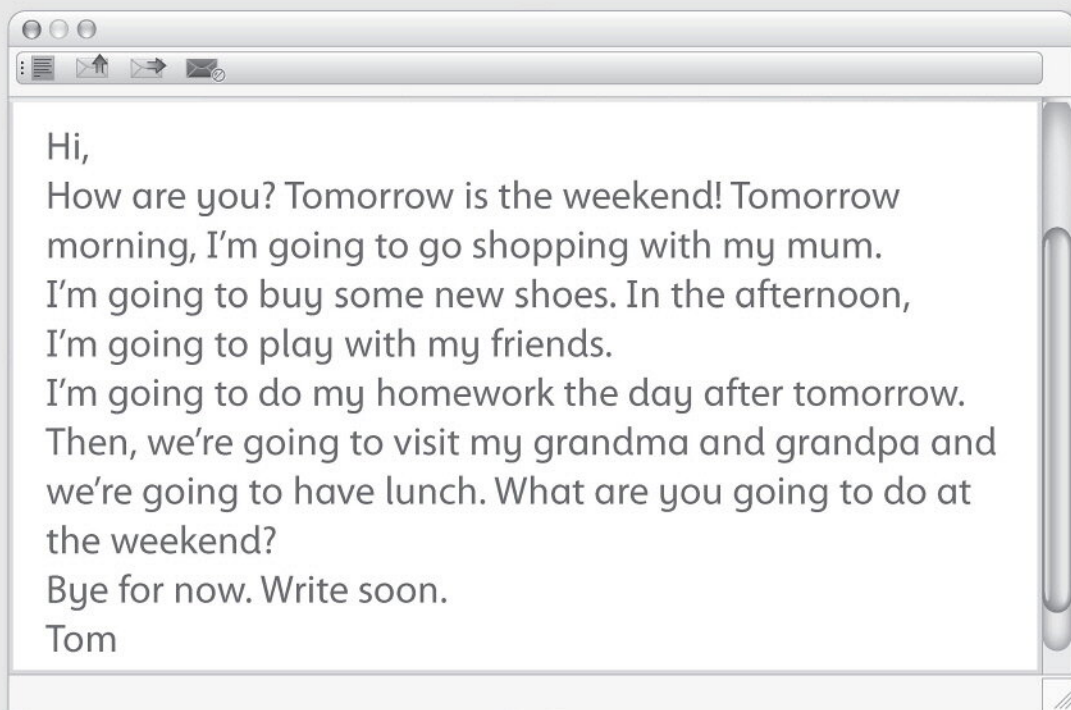

3 What are you going to do this weekend? Write an email to Tom.

Everyday English

1 Look and match.

Max

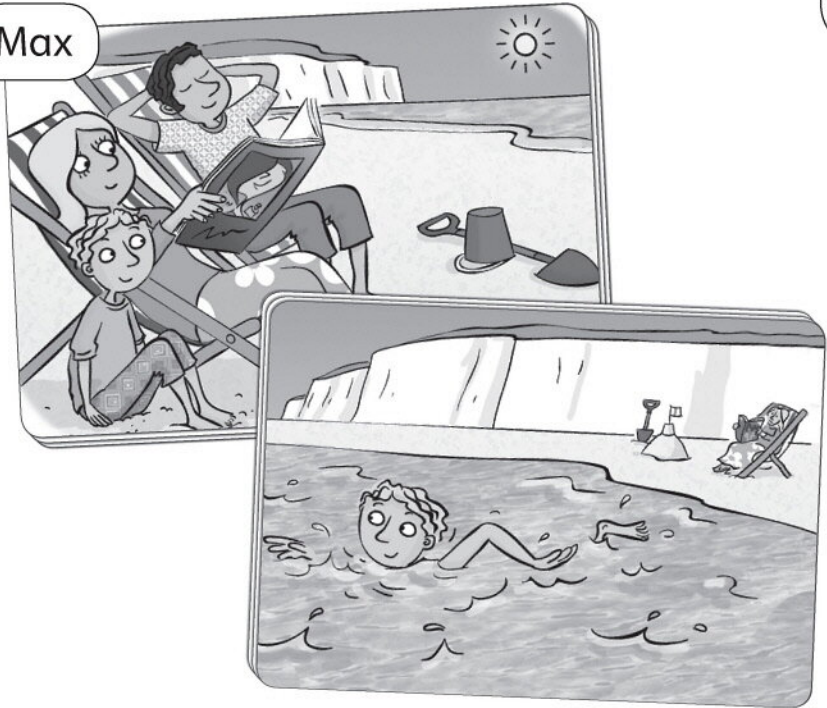

Jerry



- 1 Where did Max go on holiday?
- 2 Who did Max go with?
- 3 What was Max's holiday like?
- 4 What was the best part of Max's holiday?
- 5 Where did Jerry go on holiday?
- 6 Who did Jerry go with?
- 7 What was Jerry's holiday like?
- 8 What was the best part of Jerry's holiday?

- b
-
-
-
-
-
-
-

- a He went to the mountains.
- b He went to the beach.
- c He went hiking.
- d He went swimming.
- e He went with his cousins.
- f He went with his parents.
- g It was relaxing.
- h It was exciting.

2 Write. best ~~where~~ where what who

1 Where did you go on holiday?

I went to London.

2 _____ did you go with?

With my sisters and my parents.

3 _____ did you stay?

We stayed in a hotel.

4 _____ was it like?

It was brilliant.

5 What was the _____ part?

We visited museums and we bought souvenirs.



1 Watch and circle.

- 1 Anna went to New York with **her friends** / her parents.
- 2 It was **exciting** / **brilliant**.
- 3 She **had** / **didn't have** a great time.
- 4 The best part was **shopping and sightseeing** / **shopping and sleeping**.

2 Write. Then match.

1 I / go / New York / my parents

I went to New York with my parents.

2 what / best / part / ?

3 we / buy lots of souvenirs



4 Where / you / go / ?

5 It / exciting / . / There / river / and / big lake

6 Wow! / It / look / fantastic.



3 Talk about your last holiday with a friend.

Where did you go on holiday?

I went to the beach.

1 Write the school things in the backpack. Write the holiday things in the suitcase.

shampoo hairbrush apron lunch box sun cream
toothpaste dictionary calculator soap towel PE kit

My school things

I'm going to school tomorrow.
I'm going to put these things
in my backpack.

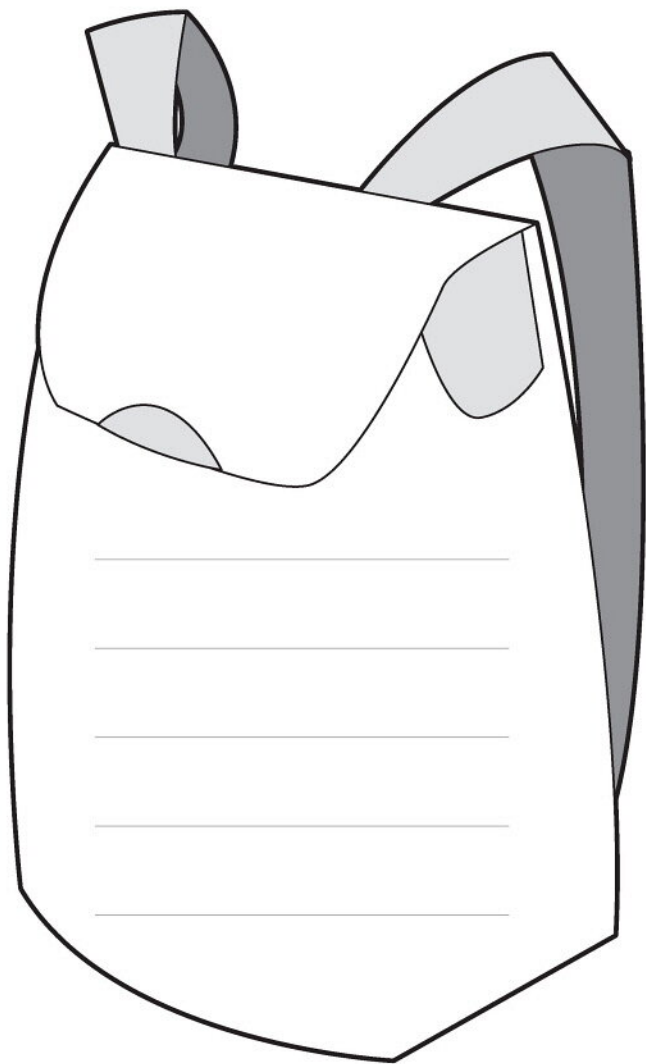

My holiday things

I'm going on holiday next week.
I'm going to put these things
in my suitcase.



2 Circle the odd one out.

- 1 tent heavy light hard
- 2 matches last night sleeping bag torch
- 3 later this afternoon rope tonight
- 4 paintbrush calculator apron soon
- 5 soft frying pan easy difficult
- 6 towel toothbrush yesterday sun cream

3 Write the correct forms of the verbs.

- 1 I'm going to cook _____ (cook) lunch tomorrow.
- 2 She played _____ (play) volleyball last Saturday.
- 3 We _____ (listen) to my new CD yesterday.
- 4 He _____ (play) football next week.
- 5 They _____ (watch) TV tonight.
- 6 I _____ (cook) dinner last weekend.

4 Write one or two words to complete the sentences.

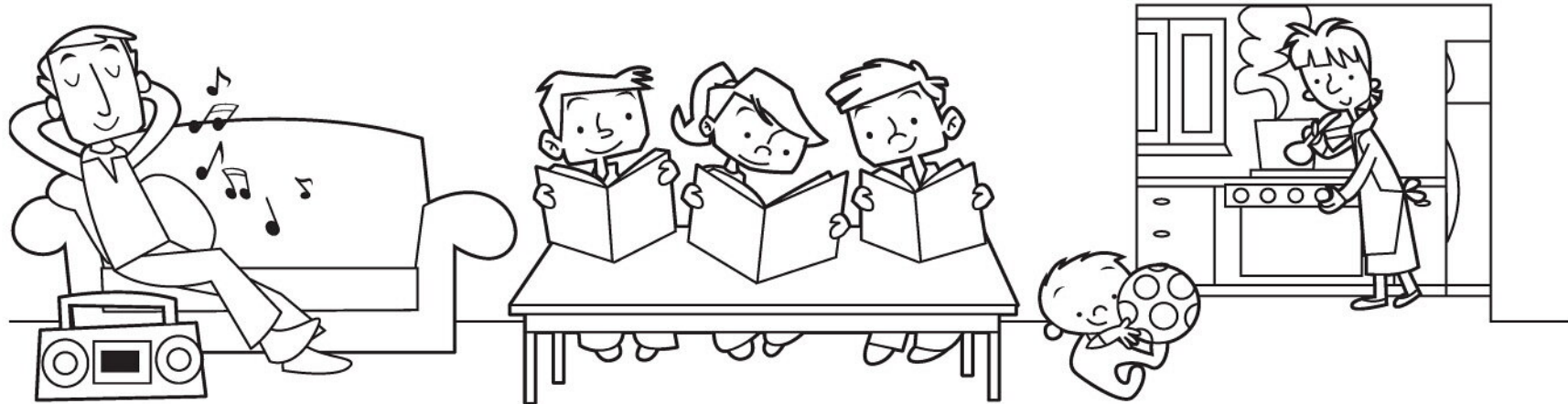

Yesterday, Dad didn't work in the garden. He stayed in the house and he _____ to music. Mum _____ go to the shops. She _____ a special dinner. The children _____ DVDs. They wanted to read their new books. The baby _____ with his ball all day. They were very happy!

My work

My favourite story in Units 13–15 is _____

My favourite song in Units 13–15 is _____

My favourite unit in Units 13–15 is _____

I need to practise _____

My work in Units 13–15 is



OK



Good



Excellent

The United Kingdom

1 Read and write.

as big as as long as as old as



Hello! My name's Kira and I'm from Oxford, a city in England. Oxford is a small city – it isn't _____ London. Oxford University is famous. It's almost _____ Bologna University, the oldest university in the world.

This is the High Street in Oxford. There are lots of university buildings here. They're beautiful. The High Street and Broad Street are famous streets in Oxford. Broad Street isn't _____ the High Street, but it has beautiful buildings, too.



2 Read the Class Book. Write *T* (true) or *F* (false).

- The Millennium Stadium isn't as modern as the Millennium Centre. T
- Princes Street in Edinburgh is almost as long as the Royal Mile.
- The Tower of London isn't as old as Buckingham Palace.
- Belfast is almost as big as London.

3 Write.

small big modern old

- The museum is as old as the library.
- The museum isn't _____ the library.
- The cinema is _____ the school.
- The cinema isn't _____ the school.
- The supermarket isn't _____ the shopping mall.
- The supermarket is _____ the shopping mall.
- The café is _____ the post office.
- The café isn't _____ the post office.



Sports events

1 Read and circle.

The London Marathon is a running race through the streets of London. It is a race for men and women. The first race was in 1981. It is a very long race.

The runners warm up before the race. When the race starts, they run very ¹ **quickly / sadly**. At the end of the race, the winner smiles ² **loudly / happily**.

More than 30,000 people take part in the race and 1,000,000 go to London to watch the race every year. They stand in the streets and they shout ³ **loudly / slowly**. You can also sit ⁴ **quietly / quickly** at home and watch the race on TV.



2 Read the Class Book and write.

fast happily quietly slowly

- 1 At Wimbledon, people sit _____ during the matches.
- 2 At Wembley, the football fans shout _____ when their team scores a goal.
- 3 The rowers in the Boat Race make the boats move very _____.
- 4 At Royal Ascot, the horses walk _____ around the 'walking ring'.

3 Read the Class Book and write.

- 1 Do the horses at Royal Ascot run slowly?
No, they don't. They run quickly.
- 2 Do the ball boys and ball girls work loudly?

- 3 Do the football fans shout sadly when their team scores a goal?

- 4 Do the boats in the Boat Race go slowly?

Clothes

1 Read and circle.

a

Hi! My name's Jess and I'm nine years old.
 I wear a ¹ **costume** / **uniform** to go to school:
 a black ² **skirt** / **shoe** and a white ³ **dress** / **shirt**.
 I like going out with my family and friends.
 I wear ⁴ **a coat** / **a T-shirt** to go out in winter.
 I wear ⁵ **smart clothes** / **a tracksuit** to go to
 a restaurant with my mum and dad. Tomorrow,
 I'm going to go to a party. I'm going to wear
 my ⁶ **favourite top** / **old jeans**. It's new!



b

Hello! I'm Brendan and I'm ten. I like wearing casual
 clothes. In summer, I wear ¹ **shorts and a T-shirt** /
a scarf to play tennis or volleyball. I wear ² **a tracksuit** /
smart clothes to help my dad in the garden.
 Last month, Dad and I painted my bedroom, and I
 wore ³ **my favourite shirt** / **old clothes**! My school
⁴ **uniform** / **tie** is grey ⁵ **trousers** / **clothes** and a white
 shirt. I also wear a blue and yellow ⁶ **tie** / **shoe**.

2 Read the Class Book and match the sentence halves.

- | | | |
|--|-----------------------------------|--|
| 1 Robbie wears a jumper | <input type="checkbox"/> b | a to act in plays. |
| 2 Gemma wears a uniform | <input type="checkbox"/> | b to keep warm in the winter. |
| 3 Gemma wears a skirt and a pretty top | <input type="checkbox"/> | c to relax. |
| 4 Ben wears tracksuits | <input type="checkbox"/> | d to go to school. |
| 5 Lisa wears jeans with colourful tops | <input type="checkbox"/> | e to visit her grandparents at the weekend. |
| 6 Lisa wears costumes | <input type="checkbox"/> | f to hang out with her friends. |

Fluency Time! 1

I like painting!
I don't like skateboarding.
I love fishing.

So do I!
Neither do I.
I don't. I prefer reading comics.

Fluency Time! 2

She's very good at swimming.
He's quite good at snorkelling.

He's bad at maths.
I'm terrible at cooking.

Fluency Time! 3

Excuse me. Where's the cinema?

Can you tell me the way to
Green Street, please?

It's in Green Street. It's next to
the museum. You can't miss it.
Sure. Turn left at the post office.
Go straight on, then turn right
into Green Street.

Fluency Time! 4

That's Sam. Do you know him?

What's Sam like? He looks shy.

No, I don't. But I know that he goes
to my school.
I think he's sometimes shy. But he's
very nice.

Fluency Time! 5

Where did you go on holiday?
Wow! Lucky you! What was it like?
What was the best part?

Cool! Thanks!

I went to New York with my family.
It was brilliant! I had a great time.
We went sightseeing and shopping.
We bought lots of souvenirs. Here's
one for you!

Fluency Time!

Review

1 Play and say. Write.

START

1

I don't like fishing.

Neither do I.

Go
back
1

2

3

you / good / art?



Go
forward
3

12

Where / you /
go / holiday?

I went to the mountains.

11

Go
back
1

10

13

I like reading comics.

So / I

14

Go
back
3

Who did you go
on holiday with?

I / went /
grandparents

15

Go
back
3

16

4

Go forward
3

5

What was the best part of your holiday?

I / stayed / tent

6

Go back
1

7

I / very good / skateboarding



9

Go forward
1

8



Can / tell / me / way / cinema?

17

I / know / Paul / very kind and generous.



18

Excuse me. Where's the sports centre?

Go / straight / can't / miss it.

You are the winner!

Unit 1 Present simple with *be*

affirmative	
I'm	from Egypt.
You're	from Spain.
He's	from Thailand.
She'	from the USA.
We're	from Australia.
They're	from Brazil.

questions		
Where	am I	from?
Where	are you	_____?
_____	is he	from?
Where	is she	from?
Where	are _____	from?
Where	are they	from?

1 Complete.

- Where is she from? _____ She's _____ from the USA.
- Where are Tom and Jane from? _____ from Australia.
- Where _____ from? He's from Spain.
- Where _____ from? We're from Thailand.

Unit 2 *like / don't like + ing*

affirmative		
I	like	playing volleyball.
You	like	skateboarding.
He	likes	play _____ football.
_____	like	doing gymnastics.
They	like	take _____ photos.

negative		
I	don't like	fishing.
You	don't like	play _____ basketball.
_____	doesn't like	taking photos.
We	don't like	playing volleyball.
They	don't	_____ reading comics.

1 Complete the sentences. (X = not like, ✓ = like)

- They don't like doing gymnastics. (X)
- He _____ playing basketball. (✓)
- We _____ skateboarding. (✓)
- You _____ reading comics. (X)
- I _____ taking photos. (✓)
- She _____ fishing. (X)

Questions with *Do / Does*

questions	short answers
<u>Do</u> I like taking photos?	Yes, I do. / No, I don't.
Do you like play _____ chess?	Yes, you do. / No, _____ don't.
Does she like skateboarding?	_____, she does. / No, she doesn't.
Do _____ like fishing?	Yes, we _____. / No, we don't.
Do they _____ doing gymnastics?	Yes, they do. / _____, they don't.

2 Complete the questions with *Do* or *Does*. Then write short answers that are true for you.

- Do you like doing gymnastics? _____
- _____ your mum and dad like taking photos? _____
- _____ your best friend like skateboarding? _____
- _____ you like playing chess? _____
- _____ you like going to the park? _____
- _____ your friends like fishing? _____

Unit 3 *your / our / their*

You've got a CD player.	Your CD player is big.
We've got a camera.	Our camera is small.
They've got a computer.	Their computer is new.

1 Complete the sentences with *your, our* or *their*.

- We've got a new DVD player. Our new DVD player is small.
- Lisa and Jim are playing with _____ friends.
- Can you put on _____ coat, please?
- We're reading _____ books together.
- Can I use _____ camera, please?
- The children are using _____ new computer.

can / can't

questions	short answers
<u>Can</u> I use your computer?	Yes, I can. / _____, I can't.
_____ you turn off the TV?	_____, you can. / No, you can't.
Can he read a book?	Yes, he can. / No, he _____.
Can they listen to a CD?	Yes, they _____. / No, they can't.

2 Complete the questions. Then write the answers. (X = no, ✓ = yes)

have close listen ~~read~~ turn

- Can I read your book, please? (X) No, you can't.
- _____ he _____ off the computer? (✓) _____
- _____ we _____ the window? (✓) _____
- _____ she _____ to a CD? (X) _____
- _____ they _____ dinner at our house? (X) _____

Unit 4 Present continuous (be verb + ing)

affirmative	
I <u>'m</u>	swimming.
You <u>'re</u>	sail _____.
She <u>'s</u>	surfing.
_____ <u>'re</u>	kayaking.
They <u>'re</u>	windsurfing.

negative	
I <u>'m not</u>	snorkelling.
You <u>aren't</u>	waterskiing.
She <u>isn't</u>	swim _____.
We <u>aren't</u>	diving.
_____ <u>aren't</u>	sailing.

1 Write sentences.

- I'm diving. I'm not sailing. (not sail)
- She's snorkelling. _____ (not waterski)
- They're eating. _____ (not play)
- We aren't sleeping. _____ (read)
- You aren't windsurfing. _____ (surf)

Unit 5 Present continuous questions and short answers

questions			short answers
Am	I	reading?	Yes, I <u>am</u> . / No, I'm not.
Are	you	painting?	Yes, you <u>are</u> . / _____, you aren't.
Is	she	eating?	_____, she <u>is</u> . / No, she isn't.
Are	_____	shopping?	Yes, we <u>are</u> . / No, we aren't.
Are	they	fly_____?	Yes, _____ <u>are</u> . / No, they aren't.

1 Complete the questions. Then write short answers. (X = no, ✓ = yes)

- Are they windsurfing? (X) No, they aren't.
- _____ she snorkelling? (✓) _____
- _____ I surfing? (✓) _____
- _____ he diving? (X) _____
- _____ you swimming? (X) _____

Unit 6 Present simple

affirmative		
I	have	a shower at night.
You	get	up early.
_____	works	on a farm.
We	walk	to school.
They	_____	the bus.

negative		
I	<u>don't have</u>	a shower in the morning.
_____	don't get	up late.
He	doesn't work	in a school.
_____	don't walk	home.
They	_____ catch	the train.

1 Complete the sentences.

- You have breakfast in the morning. You don't have _____ dinner in the morning.
- She doesn't live in the UK. She _____ in Brazil.
- We finish school at three o'clock. We _____ school at four o'clock.
- I don't do my homework in the morning. I _____ my homework at night.
- He gets up at seven o'clock. He _____ at eight o'clock.
- They don't walk to school. They _____ the bus.

Present simple questions and short answers

questions	short answers
<u>Do</u> I walk to school?	Yes, I do. / No, I don't.
Do you live in Russia?	Yes, you do. / _____, you don't.
Does _____ work in a school?	_____, she does. / No, she doesn't.
_____ we catch the bus?	Yes, _____ do. / No, we don't.
Do they get up early?	Yes, they _____. / No, they _____.

2 Complete the questions. Then write short answers. (X = no, ✓ = yes)

- Does he get up at eight o'clock? (X) No, he doesn't.
- _____ we have breakfast with our family? (✓) _____
- _____ she live in a small house? (✓) _____
- _____ they walk to school? (X) _____

Unit 7 Adverbs of frequency: *always, sometimes, never*

I **always** get up at eight o'clock.

He **sometimes** watches TV in the morning.

They **never** go to bed late.

1 Order the words. Write true sentences about you. Use *always, sometimes* or *never*.

- have / family. / I / with / breakfast / my I always have breakfast with my family.
- homework / in / I / my / do / the morning. _____
- at / brush / I / my / teeth / night. _____

Prepositions of time: *on, at, in*

He doesn't work **on** Saturdays. I get up **at** eight o'clock. We don't go to school **in** August.

2 Complete the questions with *on, at* or *in*. Then answer the questions.

- Do you go to school in February? Yes, I do.
- Does school start _____ nine o'clock? _____
- Do you get up late _____ Saturdays? _____
- Is your birthday _____ November? _____

Unit 8 Countable and uncountable nouns with *a, an* and *some*

affirmative		
I 'd like	a	sandwich.
You'd like	an	orange.
She'd _____	some	rice.
We'd like	some	apples.
_____ 'd like	some	cereal.

questions		
Would I like	a	sandwich?
_____ you like	an	orange?
Would she like	some	rice?
Would we _____	some	apples?
Would they like	some	cereal?

1 Write *a, an* or *some*.

- | | | |
|--------------------|-----------------|-----------------|
| 1 <u>some</u> rice | 2 _____ apple | 3 _____ bananas |
| 4 _____ water | 5 _____ lemon | 6 _____ bread |
| 7 _____ biscuit | 8 _____ oranges | 9 _____ cereal |
| 10 _____ meat | 11 _____ melon | 12 _____ egg |

Unit 9 Comparatives and superlatives

comparative		
Colin is	faster than	Billy.
An apple is	_____ than	a melon.
The USA is	bigger _____	Spain.

superlative	
Tom is	the <u>fastest</u> .
A grape is	the smallest.
Russia is	_____ biggest country.

1 Complete the sentences with comparatives and superlatives.

- Carl is shorter (short) than Fred.
- Adam is _____ (tall) than Carl.
- Fred is the _____ (tall).
- Mice are _____ (small) than elephants.
- Cheetahs are _____ (big) than mice.
- Elephants are the _____ (big).
- A car is _____ (slow) than a plane.
- A plane is the _____ (fast).

Unit 10 *must / mustn't*

affirmative	
You	<u>must</u> walk on the path.
We	_____ play in the playground.

negative	
We	mustn't walk on the grass.
They	_____ play in the fountain.

1 Write *must* or *mustn't*.

School rules

- 1 You mustn't read comics at school.
- 2 You _____ listen to the teacher.
- 3 You _____ talk in class.
- 4 You _____ ride your bike in the playground.

Unit 11 *There was / were, There wasn't / weren't*

There was a park in our town a hundred years ago.
There were trams in our town a hundred years ago.
There wasn't a supermarket in our town a hundred years ago.
There weren't any cars in our town a hundred years ago.

lots of, some, any

There were lots of cheese sandwiches.
There were some tomato sandwiches.
There weren't any chicken sandwiches.

1 Circle the correct words.

- 1 There were / was lots of flowers.
- 2 There **wasn't** / weren't a fountain.
- 3 There **was** / were a playground.
- 4 There **was** / were lots of trees.

Time words and phrases

Yesterday Last week Last year Last Monday Two years ago Then

2 Complete the sentences. Write about you.

- 1 Yesterday, I _____.
- 2 Last week, _____.
- 3 Two years ago, _____.
- 4 Then, _____.
- 5 Last year, _____.
- 6 Last Monday, _____.

Unit 12 Past simple: *be*

affirmative		
I	<u>was</u>	short.
You	were	worried.
_____	was	young.
We	were	cheerful.
_____	were	friendly.

negative		
I	wasn't	tall.
_____	weren't	relaxed.
She	wasn't	old.
_____	weren't	miserable.
They	weren't	shy.

1 Complete the sentences.

- 1 There were sandwiches at the party. They weren't very big. (X)
- 2 I _____ hungry last night. (✓)
- 3 You _____ happy on holiday. (✓)
- 4 There was a boy in the park. He _____ friendly. (X)
- 5 We _____ at school last week. (X)
- 6 Last year, I _____ shy in class. (✓)
- 7 Yesterday, it _____ windy, but it was wet. (X)
- 8 You _____ in class yesterday. (X)

Past simple: *have*

affirmative		
I	had	pizza for lunch yesterday.
You	_____	a guitar lesson last Friday.
He	had	cereal for breakfast yesterday.
We	_____	an art lesson yesterday.
They	had	a picnic last week.

negative		
I	<u>didn't have</u>	sandwiches.
You	didn't have	a piano lesson.
He	didn't _____	bread.
We	didn't have	a music lesson.
They	_____ have	a party.

2 Complete the sentences so that they are true for you.

Yesterday ...

- I _____ a music lesson.
- I _____ sandwiches for lunch.
- I _____ cereal for breakfast.
- I _____ dinner with my family.

Unit 13 Past simple with regular verbs

affirmative		
I	started	my homework at six o'clock.
_____	worked	in a school last year.
She	wanted	a camera for her birthday.
He	laughed	at the cartoon.
We	used	a camera on holiday.
They	_____	football last weekend.

negative		
I	<u>didn't start</u>	it at five o'clock.
You	didn't work	on a farm.
_____	didn't want	a bike.
He	didn't _____	at the film.
We	_____ use	a computer.
They	didn't play	basketball.

1 Write sentences about Jim using the past simple affirmative and negative.

- finish / his homework / Sunday (✓) He finished his homework on Sunday.
- love / his dinner / Saturday (✓) _____
- cook / fish pie / Saturday (X) _____
- hate / his dinner / Sunday (X) _____

Unit 14 Past simple questions and answers

questions	short answers
<u>Did</u> I walk to school yesterday?	Yes, I did. / No, _____ didn't.
Did you have lunch at school?	Yes, you did. / _____, you didn't.
Did she paint a picture?	Yes, she _____. / No, _____ didn't.
Did _____ play tennis?	Yes, we did. / No, we _____.
_____ they visit their cousins?	Yes, _____ did. / No, they didn't.

1 Complete the questions and write short answers that are true for you.

have eat listen paint ~~walk~~ visit

- Did you walk to school yesterday? _____
- _____ you _____ a picture yesterday? _____
- _____ you _____ to music yesterday? _____
- _____ you _____ a picnic yesterday? _____
- _____ you _____ rice for lunch yesterday? _____
- _____ you _____ your grandma last week? _____

Past simple questions with *What, Where* and *When*

What <u>did</u> you have for lunch?	Sandwiches and grapes.
When _____ he visit his cousin?	Last weekend.
Where _____ we play tennis?	In the park.

2 Complete the questions.

- What did you have for dinner last night? Pizza.
- _____ did you have dinner? At home.
- _____ did you have dinner? At seven o'clock.
- _____ did you have lunch yesterday? At school.
- _____ did you have lunch? At one o'clock.
- _____ did you have for lunch? Sandwiches and an orange.

Unit 15 *be going to*

affirmative		
I'm	<u>going to</u>	buy a hairbrush.
You're	going to	have lunch.
He's	going to	play tennis.
We're	_____	visit friends.
_____ 're	going to	watch a DVD.

negative		
I'm not	going to	buy a toothbrush.
You aren't	_____	have dinner.
_____ isn't	going to	play football.
We aren't	going to	visit our cousins.
They aren't	_____	watch a play.

1 Complete the sentences. (X = no, ✓ = yes)

buy ~~have~~ visit watch

- We aren't going to have _____ a picnic. (X)
- They _____ their grandma. (✓)
- She _____ sun cream. (✓)
- You _____ TV. (X)

Questions with *be going to*

questions	short answers
Am I going to go on holiday?	Yes, I <u>am</u> . / No, I'm not.
Are you _____ take your suitcase?	Yes, you are . / No, you aren't .
Is it going to rain?	Yes, it _____ . / _____ , it isn't .
Are _____ going to swim in the sea?	_____, we are . / No, we aren't .
Are they _____ make a cake?	Yes, they _____ . / No, they aren't .

2 Complete the sentences so that they are true for you.

brush go play read

- I'm going to go _____ to school tomorrow.
- I'm _____ computer games next week.
- _____ my teeth later.
- _____ a book on Saturday.

Word List

Starter

April
August
aunt
brother
cousin
dad
December
eighty
February
fifty
forty
grandma
grandpa
January
July
June
March
May
mum
ninety
November
October
one hundred
September
seventy
sister
sixty
ten
thirty
twenty
uncle

Unit 1

Australia
autumn
Brazil

crayon
draw
drink (v)
Egypt
garden
play (v)
Russia
season
Spain
spoon
spring
straw
summer
Thailand
(the) UK
(the) USA
winter

Unit 2

bike
cook (v)
cube
do gymnastics
face
fish (v)
June
kite
paint (v)
play basketball
play chess
play the guitar
play the piano
play volleyball
read comics
rope
shop (v)
skateboard (v)

space
stone
take photos
visit (family)

Unit 3

badges
camera
car
CD player
comics
computer
DVD player
MP3 player
park
postcards
posters
scarf
shark
shells
star
stickers
turn off ...
turn on ...
TV

Unit 4

ball
beautiful
clean
dangerous
dive (v)
kayak (v)
mall
polluted
safe
sail (v)

small
snorkel (v)
surf (v)
swim (v)
tall
ugly
under
wall
waterski (v)
windsurf (v)

Unit 5

angry
camel
corn
crocodile
flamingo
fork
free
funny
horse
kangaroo
kind
lizard
monkey
paw
penguin
scared
sorry
straw
yawn (v)
zebra

Unit 6

at the weekend
boy
brush my hair /
teeth
catch the bus
coin
every day
finally
first
get dressed
get up (late /
early)
have a shower
have breakfast
next
oil
oyster
soil
then
toy
walk to school

Unit 7

actor
brown
café
cinema
clown
concert
cow
film (n)
flower
house
library
mouse
museum

play (*n*)
playground
shopping mall
shout
singer
sports centre
swimming pool
theatre
trousers

Unit 8

adult
belt
bread
butter
cereal
cheese
child
cucumber
field
lemon
meat
melon
onion
pasta
peas
pepper
potato
quilt
salt
shield

Unit 9

big
bridge
building
camp
country

deep
high
lake
lamp
long
mountain
ocean
old
plant
pond
river
sand
tent
waterfall
wide

Unit 10

bin (*n*)
case
catch
chase
cross
flowers
fountain
grass
laugh
litter
meet
Monday
path
playground
race (*n*)
rain (*n*)
shout (*v*)
train
tray
trees

Unit 11

along
at the top of
between
bus
dream
ferry
green
happy
helicopter
ice cream
in the middle of
inside
jelly
lolly
motorbike
plane
queen
taxi
through
train
tram

Unit 12

cheerful
dry
friendly
generous
handsome
light (*adj*)
mean
miserable
night
old
pretty
relaxed
shine (*v*)
shy

sky
smile
tall
worried
young

Unit 13

coat
difficult
easy
elbow
finish
hard
hate
heavy
laugh
light (*adj*)
live
love
nose
snow
soap
soft
start
stone
use (*v*)
want

Unit 14

apron
backpack
blue
boot
calculator
dictionary
frying pan
glue
have lessons

lunch box
matches (*n*)
moon
paint (*n*)
paintbrush
PE kit
rope
sleeping bag
tent
torch
tube
tune (*n*)

Unit 15

book
cook (*n*)
good
hairbrush
hat
hood
later
next week
shampoo
soap
soon
suitcase
sun cream
this afternoon
tomorrow
tonight
toothbrush
toothpaste
towel
wood
wool

2nd Edition Family and Friends

Support and
development for
the whole child



Building on the exceptionally strong skills training, phonics and civic education of the internationally best-selling first edition, **Family and Friends 2nd Edition** now brings you:

- NEW** Real-world fluency development with supporting DVD
- NEW** Interactive online practice you can assign and track
- NEW** Comprehensive assessment and testing programme, including Cambridge English: Young Learners (YLE)

Components

- **Class Book** with Student MultiROM
- **Workbook**
- **Class Audio CDs**
- **Teacher's Book Plus** with Fluency DVD, Online Practice and Assessment and Resource CD-ROM & Audio CD
- **Teacher's Resource Pack** with Story Posters, Phonics Cards and Flashcards
- **Oxford iTools** Digital Classroom Resources

Also available

- Grammar Friends
- Readers
- Oxford Primary Skills: Reading and Writing

زبان امید

www.languagecentre.ir

OXFORD
UNIVERSITY PRESS



ISBN 978-0-19-480806-4



9 780194 808064

www.oup.com/elt/familyandfriends

2nd Edition Family and Friends

Support and
development for
the whole child



Building on the exceptionally strong skills training, phonics and civic education of the internationally best-selling first edition, **Family and Friends 2nd Edition** now brings you:

- NEW** Real-world fluency development with supporting DVD
- NEW** Interactive online practice you can assign and track
- NEW** Comprehensive assessment and testing programme, including Cambridge English: Young Learners (YLE)

Components

- **Class Book** with Student MultiROM
- **Workbook**
- **Class Audio CDs**
- **Teacher's Book Plus** with Fluency DVD, Online Practice and Assessment and Resource CD-ROM & Audio CD
- **Teacher's Resource Pack** with Story Posters, Phonics Cards and Flashcards
- **Oxford iTools** Digital Classroom Resources

Also available

- Grammar Friends
- Readers
- Oxford Primary Skills: Reading and Writing

زبان امید

www.languagecentre.ir

OXFORD
UNIVERSITY PRESS

oxfordparents
Help your child with English
www.oup.com/elt/oxfordparents

ISBN 978-0-19-480806-4



9 780194 808064

www.oup.com/elt/familyandfriends